



# ICEpower ASP-Series Designers Manual

Professional Analog Amplifier w/ ICEpower Supply

Version 1.4

## Contents

---

Introduction.....	2
Important Note! .....	2
Selecting Your ICEpower ASP Configuration.....	2
DC Bus .....	4
Shielding and Grounding of Audio Signals.....	5
EMC Management .....	5
Mechanical Mounting.....	9
Thermal Design.....	10
Safety .....	11
Performance of ASP-series module with A-series hanger(s) .....	12
Notice.....	43
Appendix 1 - Recommended wiring diagram .....	44
Appendix 2 - Recommended shielding box design for parallel mounting....	45
Appendix 3 - Recommended shielding box design for perpendicular mounting.....	46

---

## Introduction

This document is intended as a design-in guide for users of the ICEpower ASP-series modules. The recommendations described in this document provides the accumulated knowledge obtained throughout the development and approval process of the ASP-series, but since no two applications are alike, the recommendations of this document can only serve as a general guideline for your specific design.

A key point of this document is that when dealing with high-power switching technologies, you are facing a design challenge regarding proper wiring and sufficient electromagnetic compatibility (EMC). These challenges can be overcome by means of proper decoupling, shielding and cabling.

## Important Note!

### 250ASP and 500ASP

Before applying the mains voltage make sure that the mains voltage selector is set correctly and the correct fuse is placed in the fuse holder on the circuit board.

**Warning!** Setting the AC-selector incorrectly or using a fuse other than the type specified in the datasheet may cause damage to the device!

### 1000ASP

Before applying the mains voltage make sure that the fuse is mounted in the correct position in the fuse holders corresponding to the available mains voltage and that the correct fuse is used.

**Warning!** Mounting the fuse in the wrong position or using a fuse other than the type specified in the datasheet may cause damage to the device!

### ±12V auxiliary outputs

Note that the auxiliary ±12V outputs are not over current protected.

**Warning!** A short circuit on these outputs may damage the device! When using the ±12V outputs to power external circuitry, ensure proper fusing to avoid damaging the module. For more information, please refer to the chapter "Fusing".

## Selecting Your ICEpower ASP Configuration

The ICEpower ASP-series is a flexible and versatile amplifier/supply system enabling easy construction of single-way and multi-way active loudspeaker systems.

### Single amplifier systems

Please refer to Appendix 1 for examples of how to wire the ASP-modules properly. These diagrams cover:

- Multi-way active speaker using passive crossover (post amp passive filtering)
- Active subwoofer using active low pass filtering (pre amp active filtering)

Please refer to the ASP datasheet for performance specifications.

### Two-or three-way active loudspeaker systems

The ASP-series has a unique DC power bus structure enabling connection and powering of one or two ICEpower A-series modules (called "hanger" modules). This feature provides for simple and easy design of two- or three-way active loudspeaker systems.

The table below shows the possible configurations

ASP module	Hanger #1	Hanger #2	System	Short-term power per channel
ICEpower250ASP	ICEpower250A	-	2-way	250 W + 250 W
ICEpower250ASP	ICEpower250A	ICEpower250A	3-way	250 W + 250 W + 250W
ICEpower500ASP	ICEpower250A	-	2-way	500 W + 250 W
ICEpower500ASP	ICEpower250A	ICEpower250A	3-way	500 W + 250 W + 250 W
ICEpower500ASP	ICEpower500A	-	2-way	500 W + 500 W
ICEpower500ASP	ICEpower500A	ICEpower250A	3-way	500 W + 500 W + 250 W
ICEpower500ASP	ICEpower500A	ICEpower500A	3-way	500 W + 500 W + 500 W
ICEpower1000ASP	ICEpower500A	-	2-way	1000 W + 500 W
ICEpower1000ASP	ICEpower500A	ICEpower500A	3-way	1000 W + 500 W + 500 W
ICEpower1000ASP	ICEpower1000A	-	2-way	1000 W + 1000 W
ICEpower1000ASP	ICEpower1000A	ICEpower500A	3-way	1000 W + 1000 W + 500 W
ICEpower1000ASP	ICEpower1000A	ICEpower1000A	3-way	1000 W + 1000 W + 1000 W

For simplicity only two examples of wiring diagrams are shown:

**Example 1:** 2-way active loudspeaker system with active crossover and dual amplifier configuration.

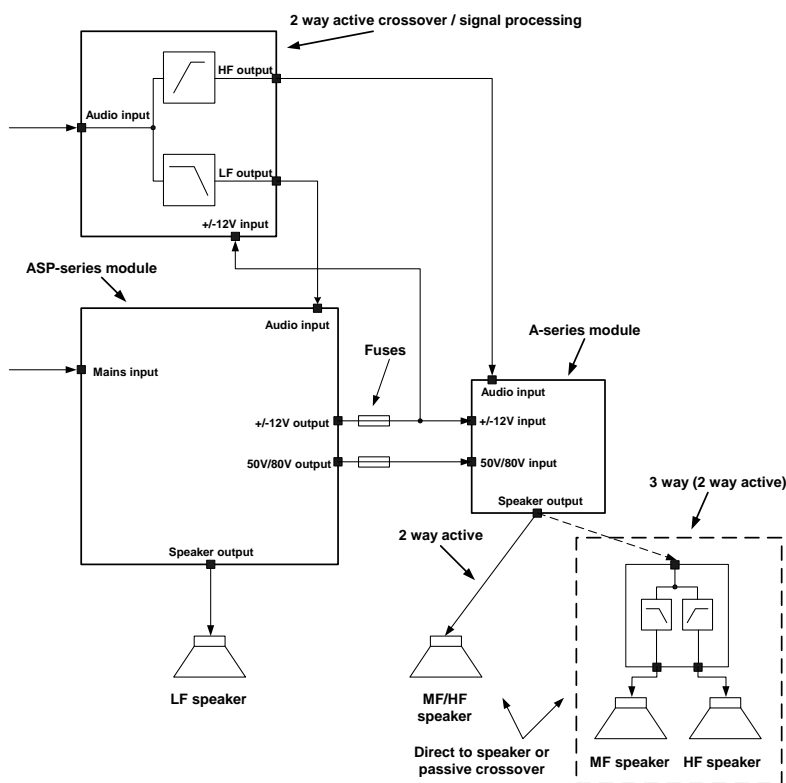

**Example 2:** 3-way active loudspeaker system with active crossover and triple amplifier configuration.

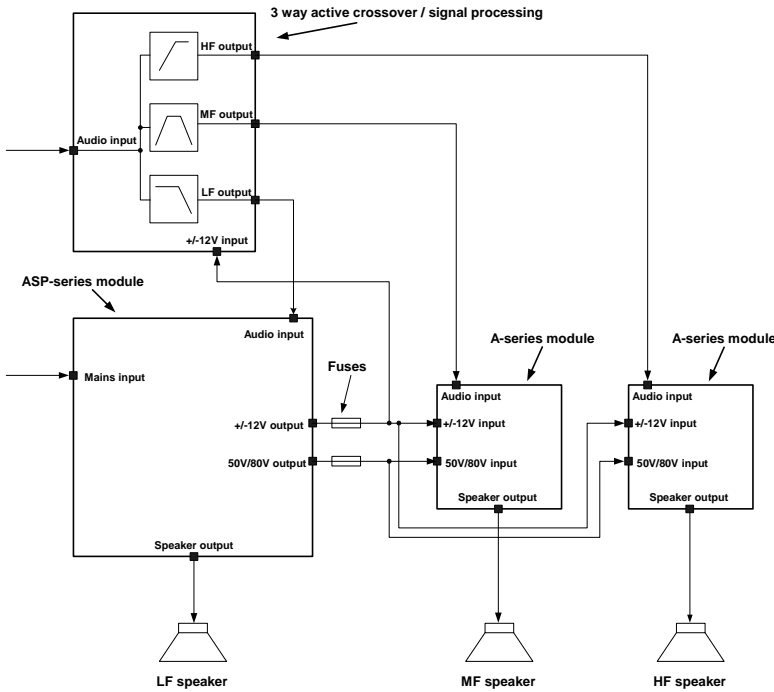

**DC Bus**

The DC bus is intended as an auxiliary DC outlet for supplying downstream ICEpower amplifiers as well as signal-conditioning electronics. The configuration of the socket and the nominal voltages are listed in the table below.

Pin number:	1	2	3	4	5	6
ICEpower250ASP	GND	N/C	GND	50 V	+12.0	-12.0
ICEpower500ASP	GND	80 V	GND	50 V	+12.0	-12.0
ICEpower1000ASP	GND	80 V	GND	120 V	+12.8	-12.8

**Fusing**

When using the DC bus, it is important to add fuses between the ±12V power supply and any external circuitry to avoid damage to the ASP-power supply in case of a failure. Fuses might be added at the high voltage outputs to avoid all power supplies dropping in case of a failure on one output.

Fuse-ratings for the individual modules

Module	12 Volts	-12 Volts	50 Volts	80 Volts	120 Volts
Fuse	Required		Optional		
ICEpower250ASP	1,0 A	1,0 A	6,3 A		
ICEpower500ASP	1,0 A	1,0 A	6,3 A	8 A	8 A
ICEpower1000ASP	1,0 A	1,0 A		8 A	10 A

Note: All fuses must be slow blow types.  
Current consumption of all external circuitry connected to the ±12 V must not exceed 0.8 A.

## Shielding and Grounding of Audio Signals

To eliminate hum and noise due to ground loops and insufficient cable shielding, schematics showing our recommended ground and shielding philosophy can be found in Appendix 1.

When dealing with switching amplifiers, unwanted frequency components at the output of the amplifier due to different switching frequencies will occur. These signals (spurious) must be kept at a minimum to avoid audibility. Avoiding spurious output requires attention to cabling and grounding.

ICEpower recommends two different basic grounding schemes

- Star ground placed at the output of the power supply
- Using the low impedance aluminum back plate as a ground plane

Both grounding schemes work flawlessly, but with slightly lower spurious when using the back plate as a ground plane. Spurious output levels below  $-120\text{dB}$  related to full power are achievable.

In the case of two hanger modules being placed in close proximity to each other, it might be necessary to place a grounded aluminum shield between the modules to achieve lowest possible spurious levels.

The analog audio signal input interface is intended for balanced signal routing. However, by shorting the negative signal input to ground a single-ended audio input interface can be derived. Short pin 1 and pin 3 at the input XLR connector as shown in Appendix 1.

## EMC Management

ICEpower amplifiers and power supplies utilize the latest switching technology to offer intelligent, compact and efficient audio power conversion systems. However, operating with fast switching signals unwanted high frequency noise is generated, which may exceed the standardized EMI limits if the necessary high frequency design precautions are not taken.

The ICEpower ASP-series has been pre-approved according to the following EMC standards:

- EN55103-1
- EN55103-2
- FCC part 15b Class A

The device under test is mounted in a shielding box (see appendix 2) and loaded with a resistive load. The test signal is pink noise corresponding to  $1/8^{\text{th}}$  of the rated power dissipated in the load.

Even though the ICEpower modules themselves are pre-approved, it is necessary to approve the final product according to the applicable standards.

## Do's and Don'ts

Electromagnetic Interference (EMI) is emitted from any cable carrying RF currents. This chapter describes some guidelines to help reduce EMI in an ICEpower system.

- Loops conducting RF currents emits EMI. It is important that speaker cables are twisted, shielded or at least run closely paralleled to reduce the loop area as much as possible. The same rule goes for mains and internal power supply cables as well as signal cables.

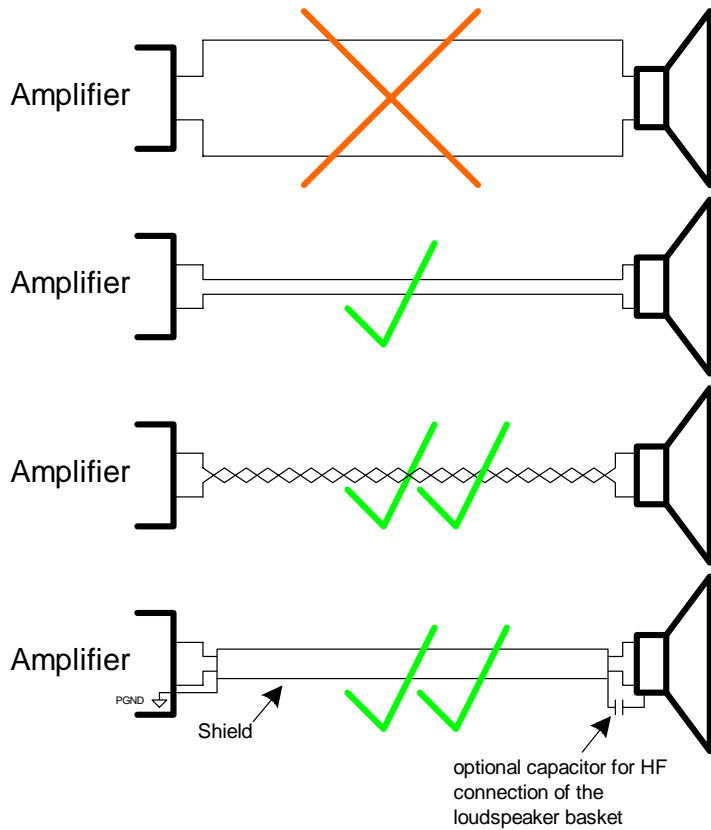

Note: When using shielded speaker cable, the shield should not be connected directly to the basket of the loudspeaker but through a small capacitor. Loudspeakers may short the voice coil to the basket during heavy load causing activation of the over current protection due to the short to ground. This will cause an amplifier shutdown and can be avoided by making the connection to the basket with a small capacitor.

- Do not run the cables to the modules near the amplifier output choke or the power supply transformer.

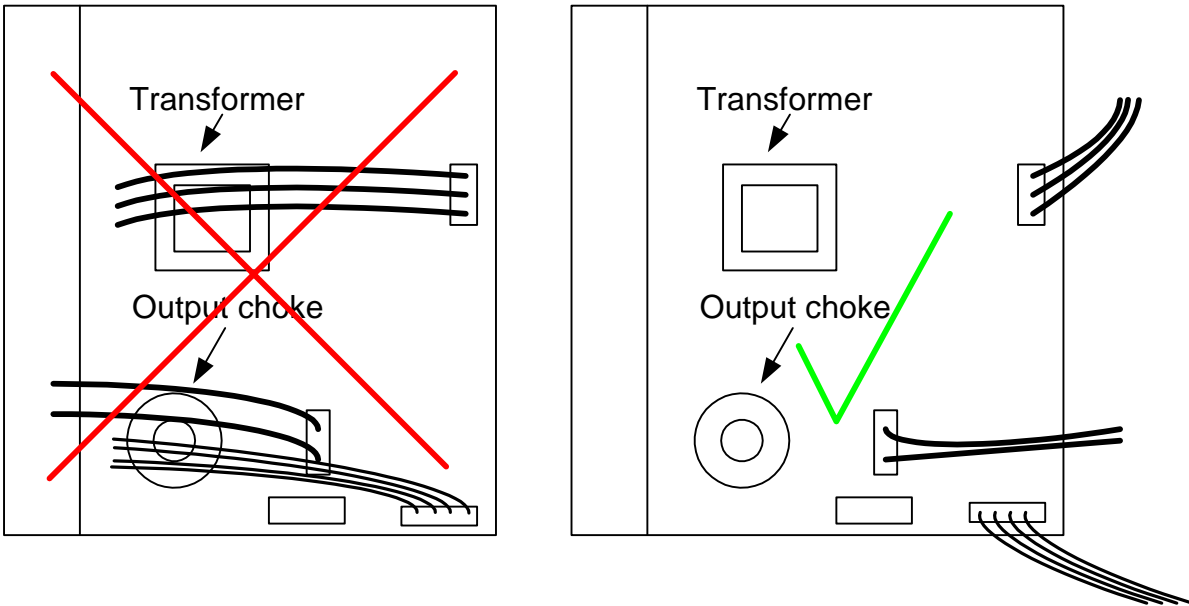

- Do not bundle input, output and mains cables to the modules.

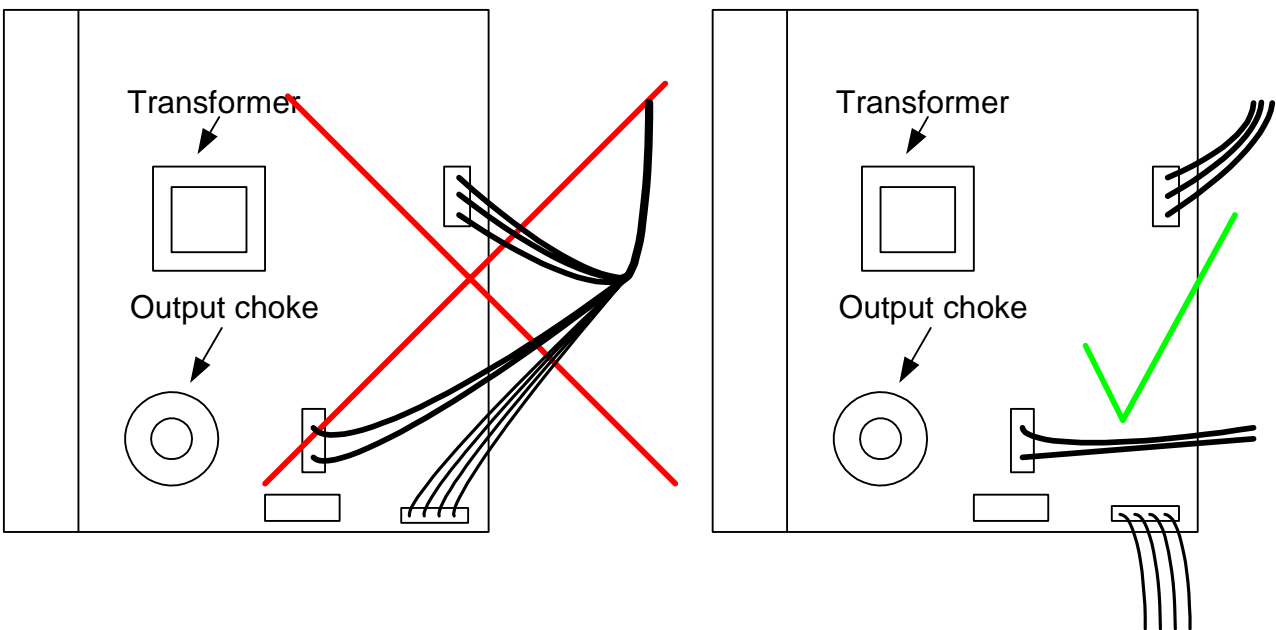

**Additional ferrites**

Depending on the application and output power requirements, additional ferrites on the speaker and mains cable might be needed to reduce the level of EMI emitted from the system to within acceptable limits. The ferrite adds common mode resistance to the cable at high frequencies thereby reducing the emission level.

Suggested ferrites:

Cable	Vendor	Vendor's part number
Speaker	Ferrox Cube	4C65
Mains	Kitagawa	RFC-10

### Design of shielding boxes

Depending on the application and applicable approval standards a shielding box may be needed.

To achieve sufficient shielding we recommend using 0.4mm tin plate or 1.5mm aluminum plate for the shielding box.

The shield must have good contact with the ground connected back plate of the ASP-module. Therefore, we recommend screws approximately every 30 to 40 mm, or if a shielding gasket is used a sufficient to compress the gasket.

To get sufficient airflow for cooling, holes in the shield are required. The holes will allow some RF noise to leak out, but if they are kept small enough the shield will still be effective. Maximum recommended hole diameter is 8mm. The number of holes depends on the application and the size of module, but good airflow is required. The holes must be evenly spaced and must not cover more than 30% of the shield area.

An example of a box with sufficient shielding capability is shown in Appendix 2 and Appendix 3.

During the ASP approval phase the following internal wiring setup were used:

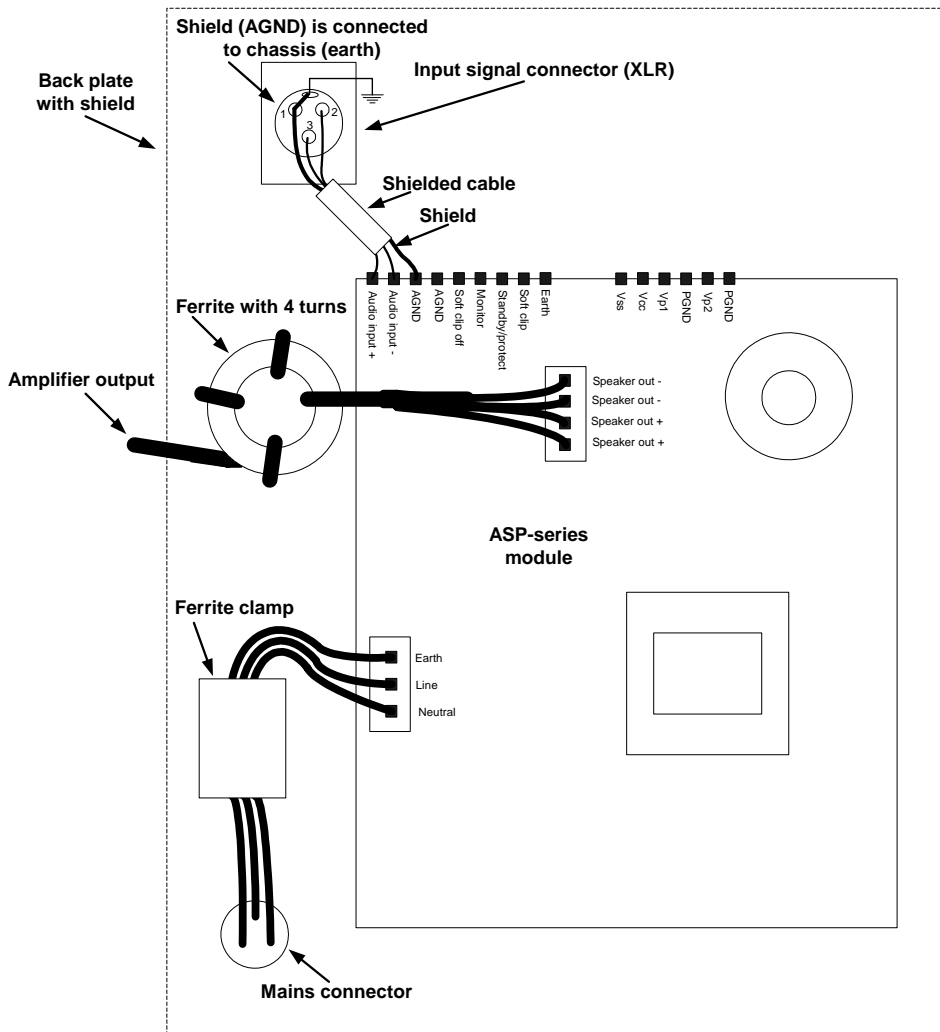

Note the proper routing of the cables.



## Mechanical Mounting

### Mounting methods

The ASP-modules are designed for mounting either inside or outside the acoustic volume of a speaker enclosure or inside a normal amplifier metal cabinet.

The module mounts parallel or perpendicular to a metal backplane, which also serves as an additional heat sink. Please refer to the mechanical drawings presented in Appendix 2 and Appendix 3.

### Recommended screws

Mounting slots that interface to 3mm thread forming screws are built into the aluminum extrusion. The table below states the number of screws necessary to withstand shocks of up to 70G. Since the perpendicular mounting method only holds the module to the backplane by one mounting slot, never mount the module this way without adding an aluminum brace between the back plane and the unused mounting slot on the opposite side. The slot used for perpendicular mounting in the backplane should always be the one located at the power transistors mounting shelf, since this is the point where the most heat is dissipated and therefore where the lowest thermal resistance to ambient should be.

The screws should be distributed evenly throughout the length of the slot.

Module type	Mounting Parallel to backplane (2 slots)	Mounting perpendicular to backplane (1 slot)
ICEpower250ASP	2 x 3 Screws	1 x 3 to backplane plus 2x3 to brace/backplane
ICEpower500ASP	2 x 4 Screws	1 x 4 to backplane plus 2x4 to brace/backplane
ICEpower1000ASP	2 x 5 Screws	1 x 5 to backplane plus 2x5 to brace/backplane

Recommend screw type:

EJOT PT Screw type DG 30 x yy WN aaaa KO

Where yy defines the length of the screw  
aaaa defines the head type and type of recess.

See [www.ejot.com](http://www.ejot.com) for further details.

It is very important that attention is paid to the length of the screw, as the strength of the joint is very sensitive to proper screw length. We recommend that you choose a screw that will sink minimum 4 mm. and maximum 5 mm. into the profile slot.

## Thermal Design

### General

Even with the high efficiency of the ICEpower ASP modules, proper thermal design is very important. The integrated ASP heat sink will be sufficient in most applications for the 250ASP and 500ASP. For the 1000ASP it is often necessary to add an additional heat sink possibly combined with a fan for extreme applications.

While additional heat sinking will be necessary it is always very important to test the thermal performance in the actual application in order to avoid using an overly large external heat sink. Contrary to a class A/B amplifier, the ICEpower amplifiers can drive reactive loads with little increase in power dissipation. Testing thermal capabilities with resistive loads may therefore lead to excessive cooling requirements and result in increased cost. Therefore, the real loudspeaker intended for the application should always be used for the thermal design tests.

When doing the thermal design and tests it is important to note that the amplifiers are to be used for music signal reproduction. Thorough investigations have shown that the RMS level of any music signal does not normally exceed  $1/8^{\text{th}}$  of the peak value. Consequently, pink noise with an RMS level corresponding to  $1/8^{\text{th}}$  of the rated maximum power should be used as the worst-case signal along with various music signals.

The ICEpower ASP modules have full onboard thermal protection for both the power supply and amplifier section. This protection circuitry shuts down the module if the temperature reaches critical levels. The temperature of the heat sink at thermal shutdown depends on the airflow around the PCB and the thermal capacity of total thermal system. Using average music signals, the heat sink temperature will normally be above 60 deg. Celsius when shutdown occurs. By adding additional heat sinking to the ASP-module, the steady-state power capability of the amplifier can be raised accordingly. We recommend that an aluminum backplane, either consisting of a piece of sheet aluminum or a 3-dimensional finned heat sink, be used for this purpose. The amount of additional heat sinking required must always be determined to suit the specific design and cost. Please refer to the relevant ASP datasheet for information on output power capability and cooling requirements.

### Mounting inside or outside the acoustic volume of a loudspeaker

Before deciding to mount the module inside an active loudspeaker it is important to note the differences between placement inside or outside the acoustic volume.

When using inside placement, it is important to secure good airflow around the modules. It is therefore very important to ensure that any acoustic damping material is never placed close to the module. Placement inside the acoustic volume of a loudspeaker can be an advantage in some applications due to the circulating air caused by the transducer movements. On the other hand, the power dissipated in the transducer raises the air temperature inside the cabinet and the advantage of inside placement is therefore very application specific.

Placement outside the acoustic volume does not offer the advantage of increased airflow caused by the transducer movement, but the ambient temperature seen by the module could be lower depending on the size of the shielding box and number of ventilation holes. Placing the module outside the acoustic volume does therefore not require the back plate to be completely airtight. Additionally, mounting the module outside the acoustic volume will help reduce the vibrations the module is exposed to.

### Using a fan

If very high average output power or operation at very high ambient temperatures is desired, a fan can be used to increase the maximum average power capability before thermal shutdown occurs. Even if there are no ventilation holes in the box, a fan will help circulate the air and reduce hot air pockets.

The highest temperatures are found in the amplifier section of the module and therefore the fan should be placed so that air is blown over the amplifier end of the PCB.

The fan should be temperature controlled to increase lifetime and reduce noise. Note that very little circulation is often enough to make large improvements compared to the normally non-circulating air inside a closed box.

The fan should only be considered for extreme applications or in cases where very little space is available for the modules since it will increase cost and complexity of the design significantly. The need for a fan should always be verified by testing the ASP module in real applications with real music signals.

## **Safety**

To ease the design-in process the ASP series have been safety approved by CSA according to the following standards.

### *Safety class*

Europe: IEC60065 6<sup>th</sup> ed. (1998)

US: UL6500 2<sup>nd</sup> ed.

CA: E60065 6<sup>th</sup> ed.

The following chapters apply to the product: §7, 10, 11, 13, 14, 15 and 20

### *Touch current*

Class 1

## Performance of ASP-series module with A-series hanger(s)

The performance measurements in this chapter demonstrate the achievable audio specifications for an ASP-series amplifier with one or two hanger modules, when using the suggested wiring. The grounding scheme with the back plate used as ground plane has been used. The measurements include spurious, crosstalk and power duration measurements for each configuration.

Six different setups are demonstrated:

- Setup 1 Two-way active speaker w/ 250ASP + 250A
- Setup 2 Two-way active speaker w/ 500ASP + 250A
- Setup 3 Three-way active speaker w/ 500ASP + 500A + 250A
- Setup 4 Three-way active speaker w/ 500ASP + 250A + 250A
- Setup 5 Two-way active speaker w/1000ASP + 500A
- Setup 6 Two-way active speaker w/1000ASP + 1000A

All measurements are done with Audio Precision System Two Cascade Plus equipment including the Audio Precision Switching Amplifier Measurement Filter AUX-0025. Channel assignment and amplifier load are described for each setup.

### Power duration measurements

The power duration measurements show the ability of the integrated power supply to handle an overdrive situation when supplying power to one or more A-series hanger modules.

The ASP-module and the hanger module(s) are pre-loaded with sine-wave signals. The modules are intentionally driven at different frequencies to allow for clearer readout on FFT and to reflect realistic loading conditions.

The combined output power of the ASP-module and the hanger module(s) under pre-load conditions corresponds to the rated output capability of the power supply. An input signal step is then introduced to push the load on the power supply to 150% of its rated output. The numbers in the tables show how long time the power supply is able to supply 150% of rated output ( $t_{150}$ ) before the integrated protection system attenuates the output.

Adding an optional capacitor on the main DC-bus will significantly increase  $t_{150}$  as evidenced by the numbers given. This can be exploited in subwoofer applications, where it results in improved ability to handle transients.

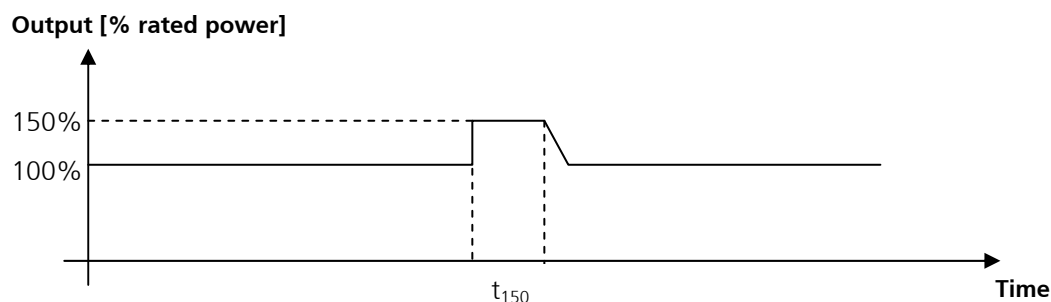

The activation of the protection system will cause soft clipping of the output, which will introduce slightly audible distortion in the signal to the speaker, but in most cases music will continue playing.

Measurements marked with \* indicate a momentary loss of output power.

When using the ASP-series with hanger module(s) in a multi-way setup, we recommend using the ASP-module to power the bass and the hanger module(s) to power midrange/tweeter. This is because introducing a power step in any of the connected A-series modules will cause the integrated protection circuits to attenuate the output level of the ASP-series module **only**. Using the ASP-series module for powering the bass will ensure optimum sound quality and stability if the system is overdriven.

**Setup 1: 250ASP with 250A hanger**

AP channel	Amplifier	Switching frequency	AP output	Load
Ch1	250ASP	394 kHz	AP1 bal GND	2.7 Ohm
Ch2	250A	446 kHz	AP2 bal GND	2.7 Ohm

THD+N vs. power

Power Sweep one module at a time.

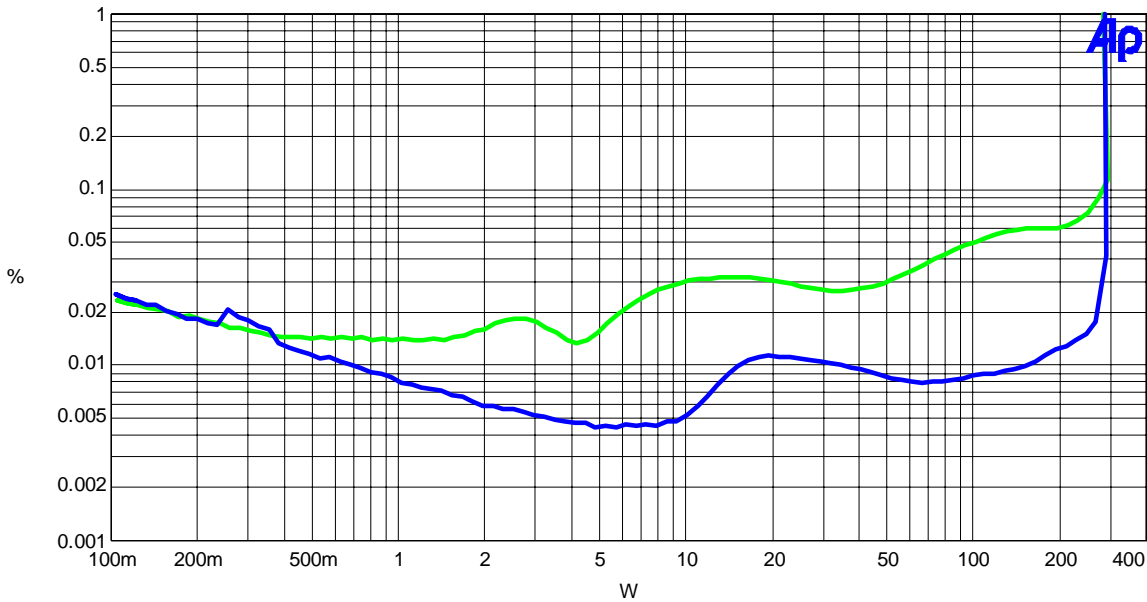

Figure 1, Setup 1 THD+N vs. power Ch1: 250ASP 1kHz and 6.66kHz

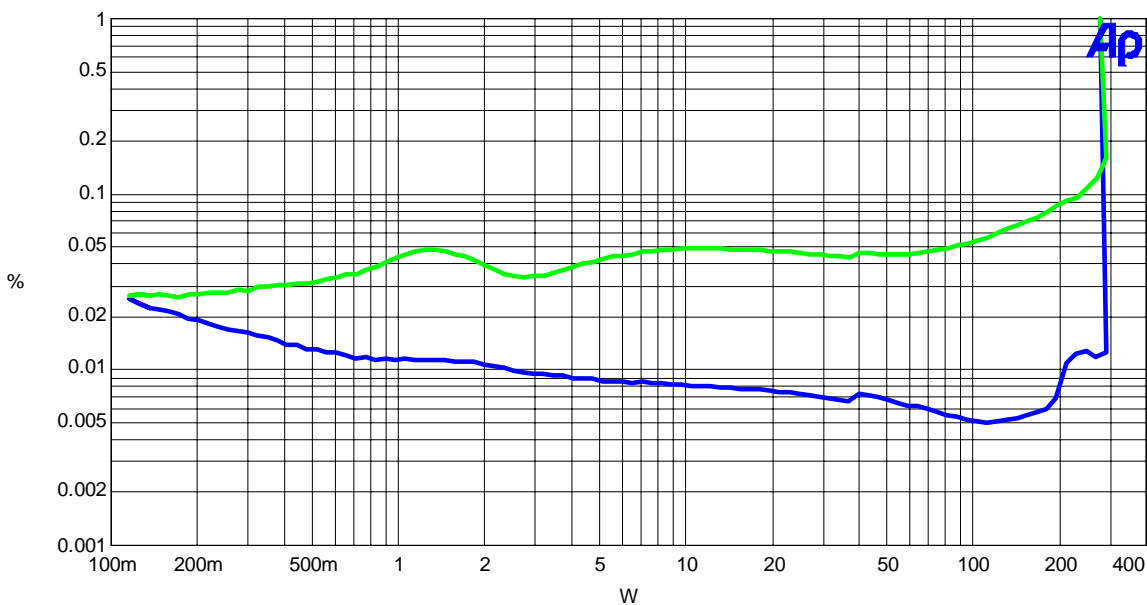

Figure 2, Setup 1 THD+N vs. power Ch2: 250A 1kHz and 6.66kHz

*Spurious*

Spurious at idle.

FFT on all modules without input

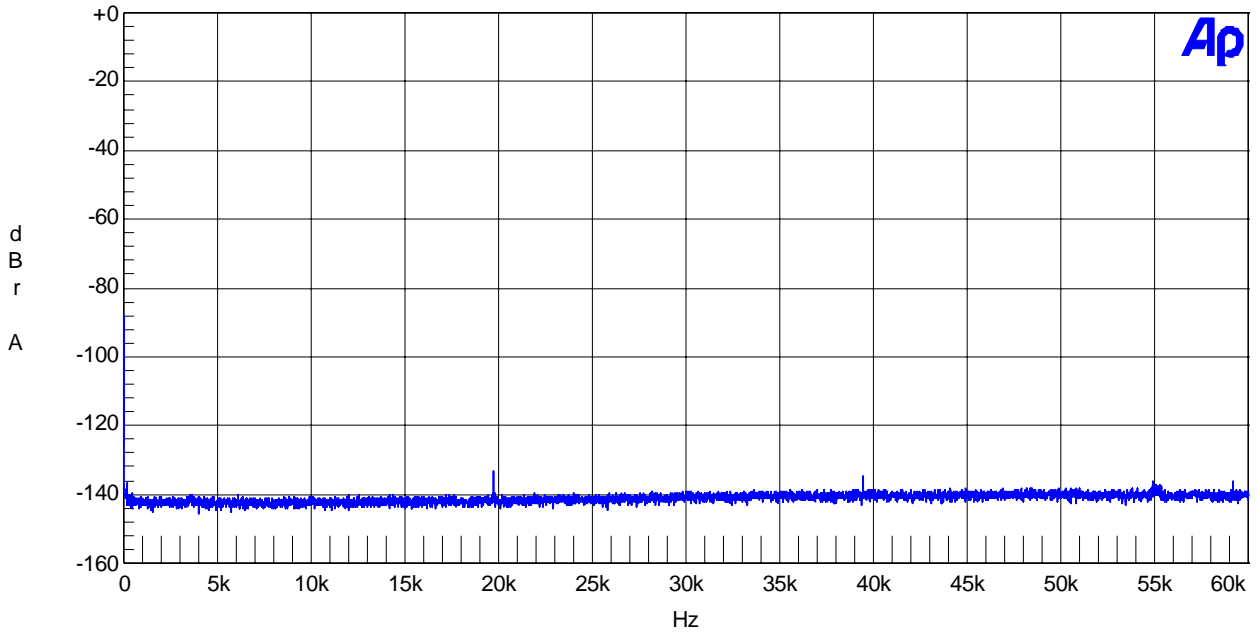

Figure 3, Setup 1 Ch1: 250ASP idle, 0db = 200 W @ 4 Ohm

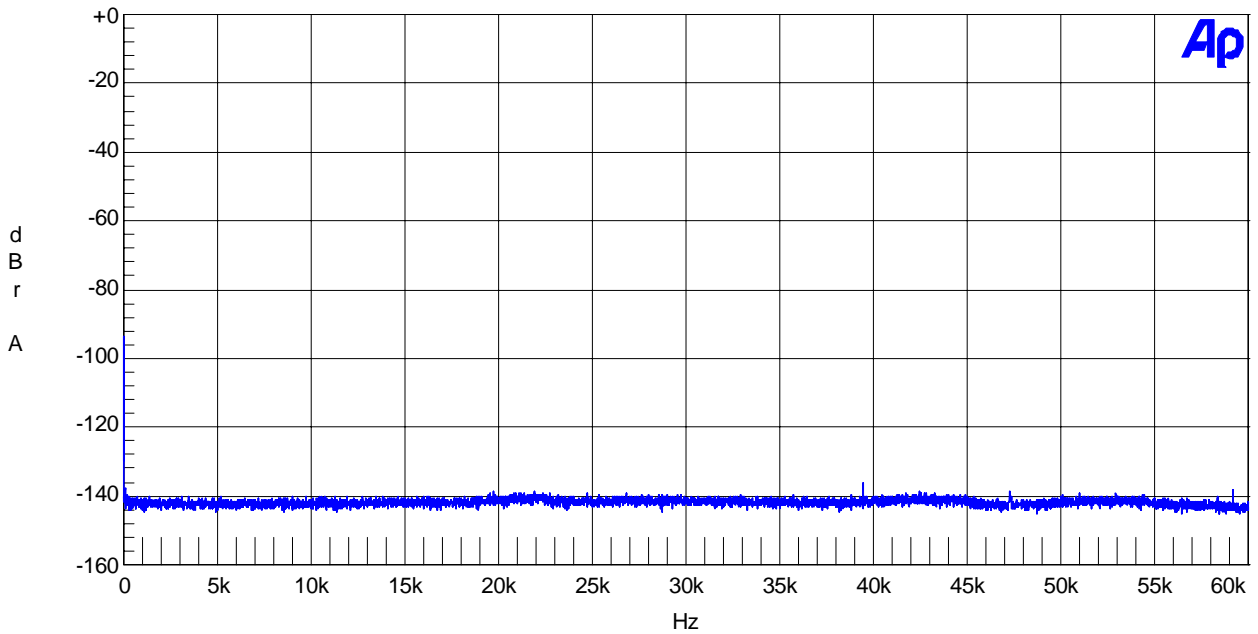

Figure 4, Setup 1 Ch2: 250A idle, 0db = 200 W @ 4 Ohm

*Dynamic range and cross modulation test*

All modules at 1/8th of full power rating with sinusoidal test tones.

Test tones Ch1: 880 Hz and Ch2 1.52 kHz

FFT on all modules

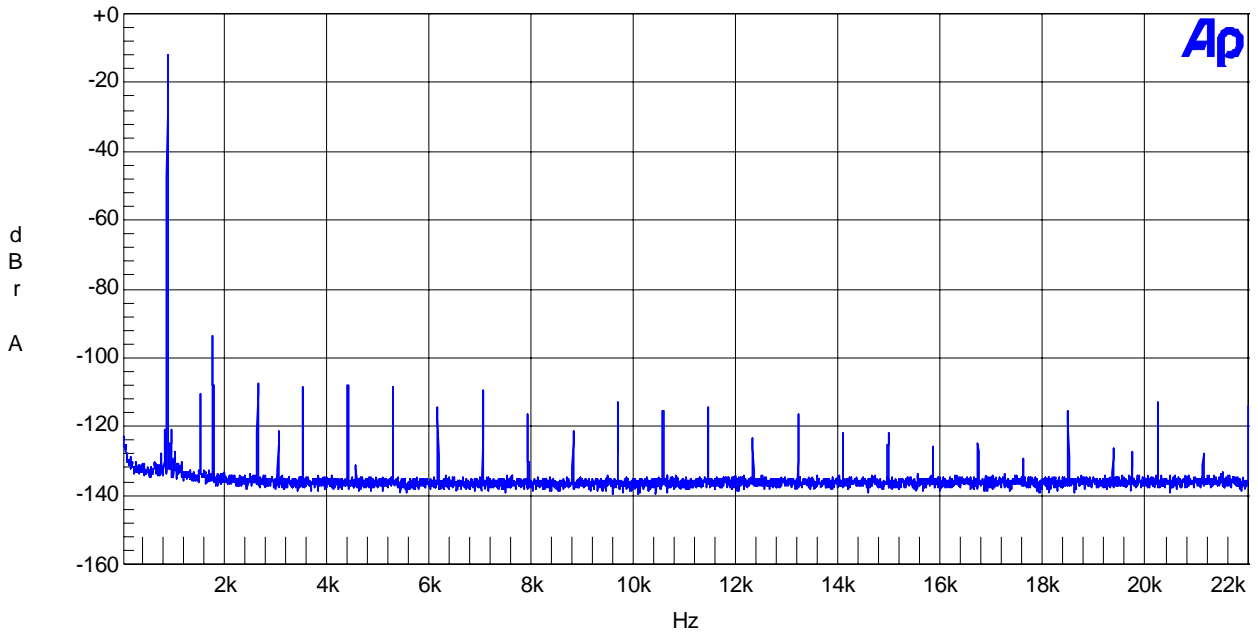

Figure 5, Setup 1 FFT on Ch1 250ASP: 0db = 200 W @ 4 Ohm

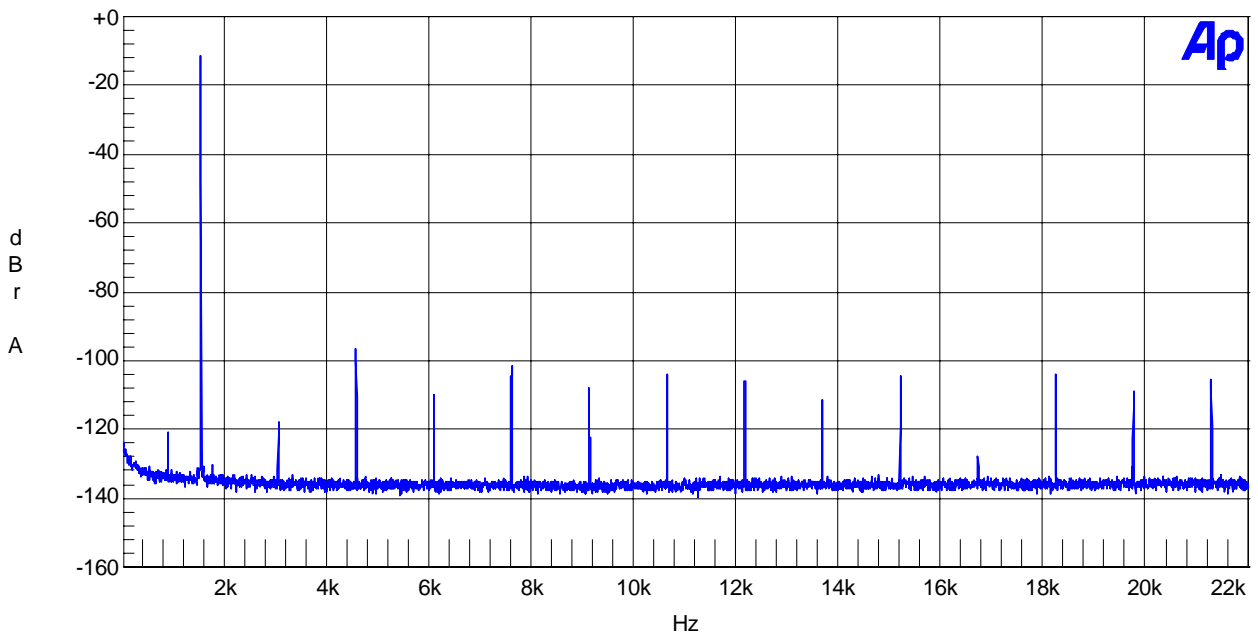

Figure 6, Setup 1 FFT on Ch2 250A: 0db = 200 W @ 4 Ohm

*Crosstalk vs. frequency*

The module is swept at 1/8th of rated power. 0 dB = 1/8th rated power

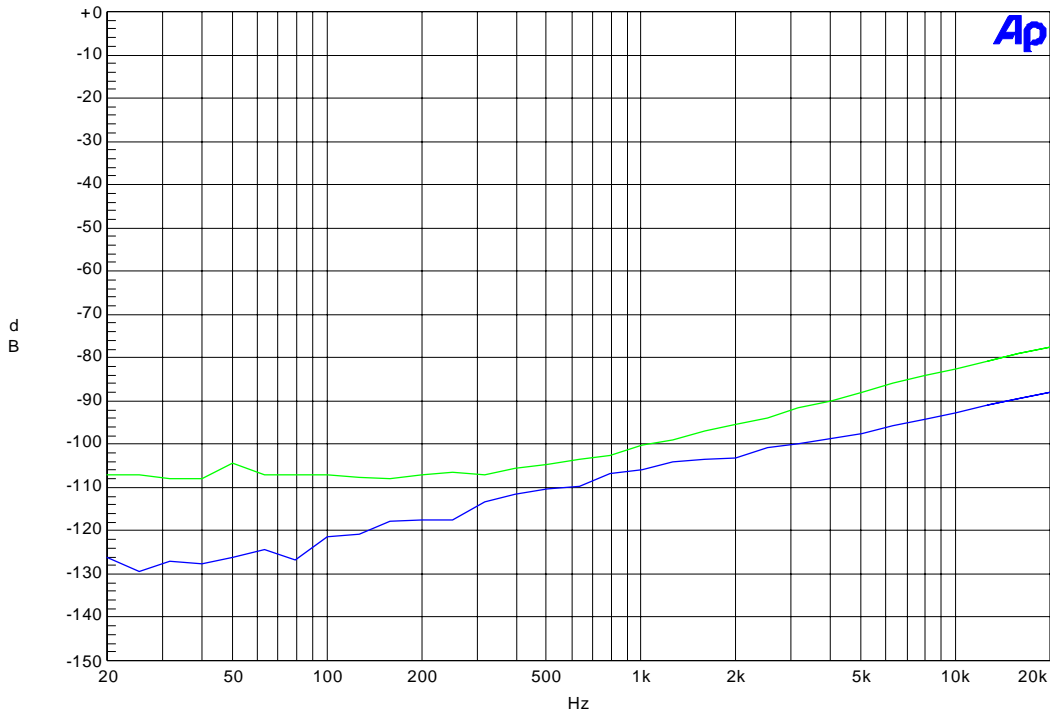

Figure 7, Setup 1 Cross talk: Ch1 250ASP to Ch2 250A and Ch2 250A to Ch1 250ASP.

*Power duration measurements*

Power duration measurements record the elapsed time after the introduction of a power step until the output is attenuated to a safe power level by the onboard protection system (Please refer to page 12 for a full description). Measurements marked with \* indicate loss of output power.

- Stepping the power load on the ASP-module

Module	Input Frequency	Preload power	Stepped power
250ASP	880 Hz	125 W @ 2.7Ω	250 W @ 2.7Ω
250A	1 kHz	125 W @ 2.7Ω	125 W @ 2.7Ω

	Power duration [ms] (t <sub>150</sub> )	
	250ASP	250A
50 Volt bus without extra capacitor	19	> 2000
50 Volt bus with extra capacitor 9400 uF	45	> 2000

- Stepping the power load on the hanger module

Module	Input Frequency	Preload power	Stepped power
250ASP	880 Hz	125 W @ 2.7Ω	125 W @ 2.7Ω
250A	1 kHz	125 W @ 2.7Ω	250 W @ 2.7Ω

	Power duration [ms] (t <sub>150</sub> )	
	250ASP	250A
50 Volt bus without extra capacitor	18	36
50 Volt bus with extra capacitor 9600 uF	40	70



**Setup 2: 500ASP with 250A hanger**

AP channel	Amplifier	Switching frequency	AP output	Load
Ch1	500ASP	431 kHz	AP1 bal GND	4 Ohm
Ch2	250A	446 kHz	AP2 bal GND	2.7 Ohm

THD+N vs. power

Standard Power Sweep one module at a time.

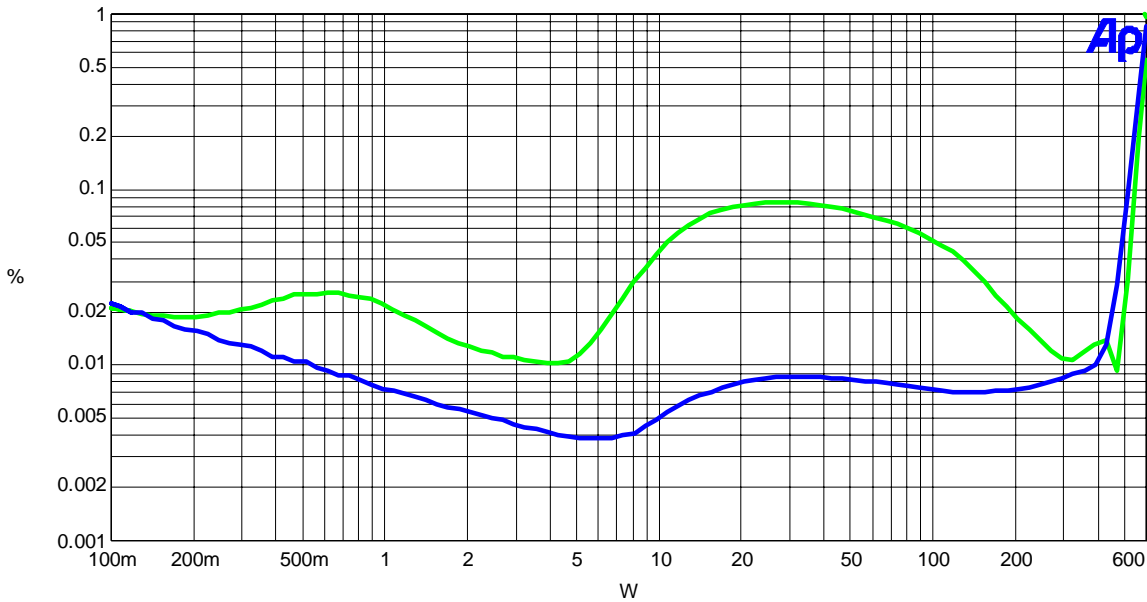

Figure 8, Setup 2 THD+N Ch1: 500ASP 1kHz and 6.66kHz

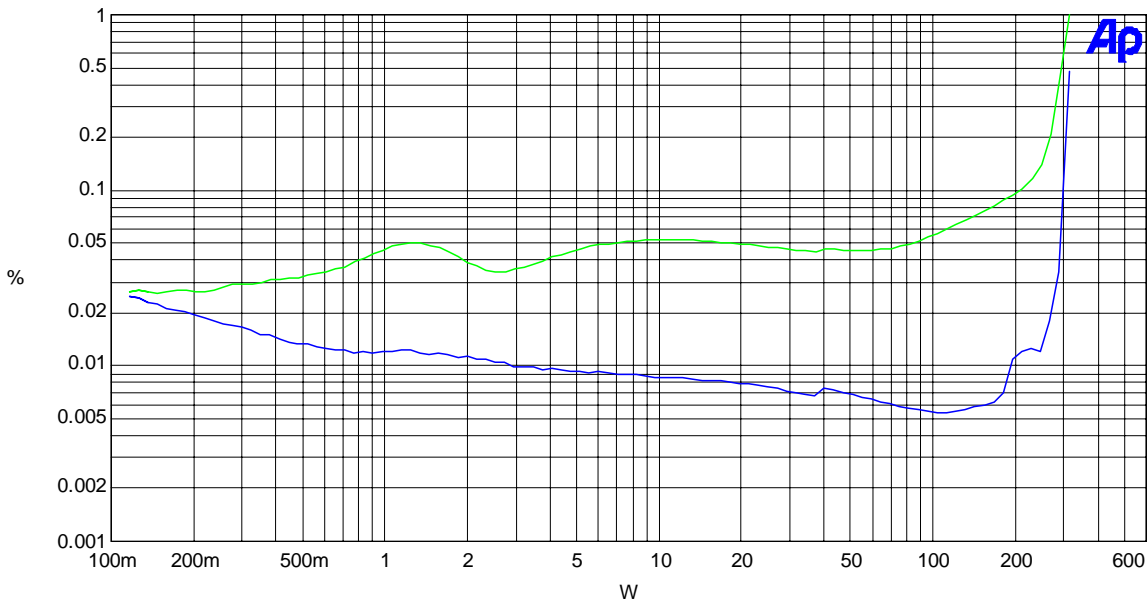

Figure 9, Setup 2 THD+N Ch2: 250A 1kHz and 6.66kHz

*Spurious*

Spurious at idle.

FFT on both modules without input

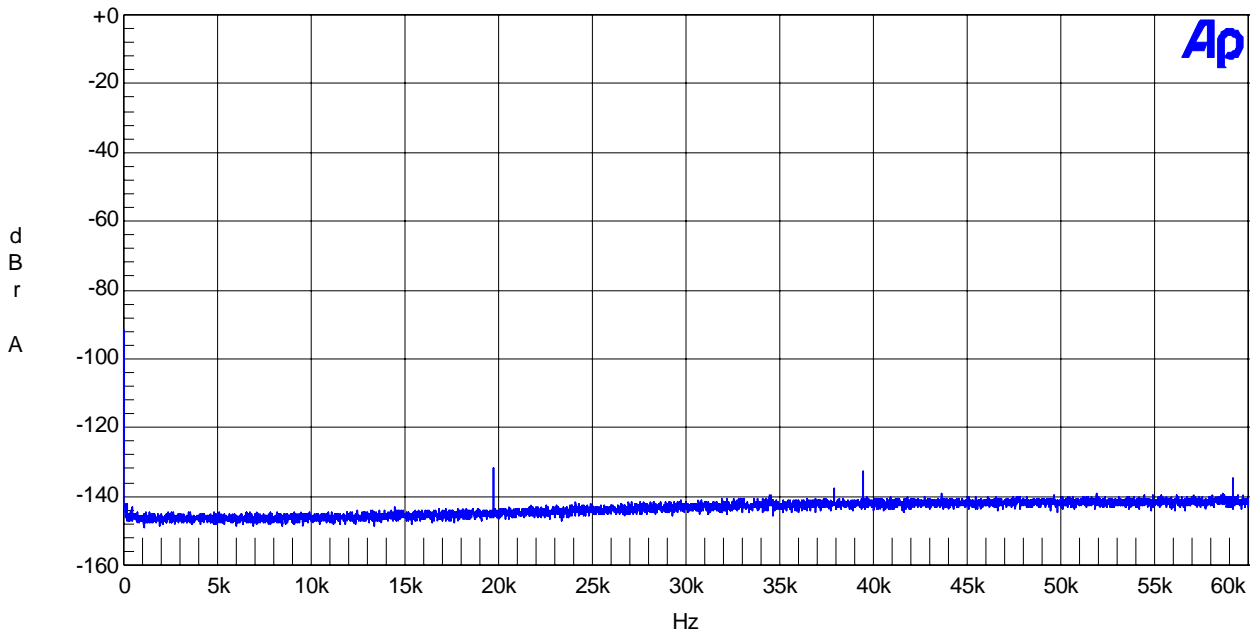

Figure 10, Setup 2 Ch1: 500ASP idle, 0db = 500W @ 4 Ohm

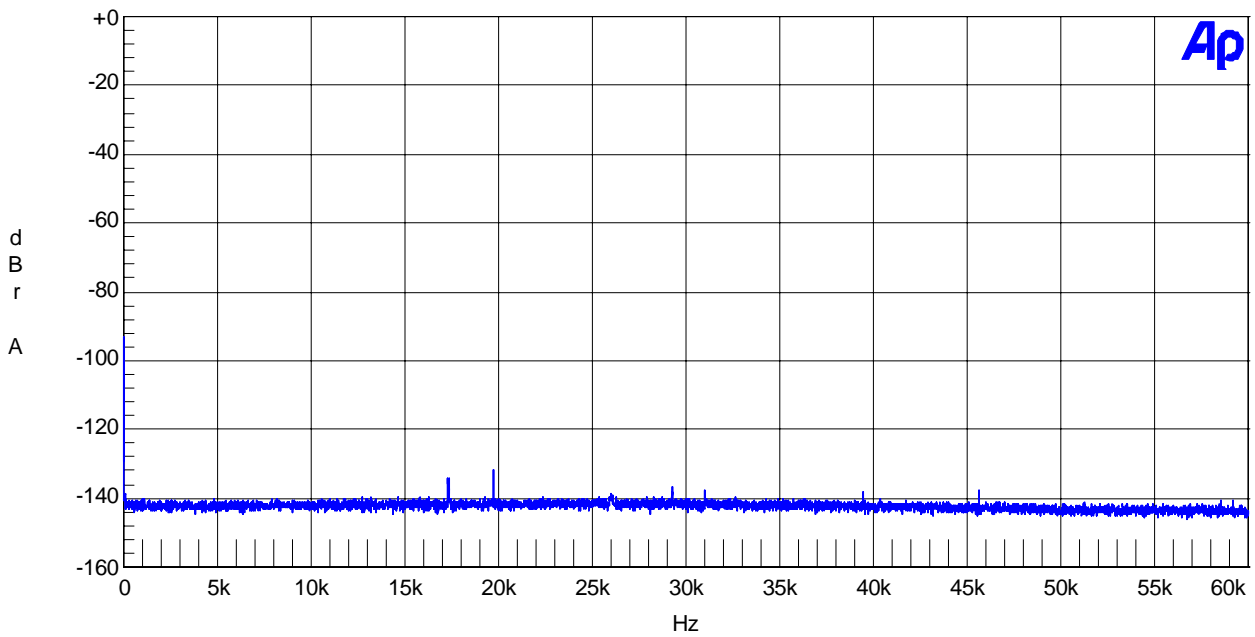

Figure 11, Setup 2 Ch2: 250A idle, 0db = 200W @ 4 Ohm

*Dynamic range and cross modulation test*

Both modules at 1/8th of full power rating with sinusoidal test tones

Test tones CH1: 880 Hz and CH2: 1.52 kHz

FFT on all modules

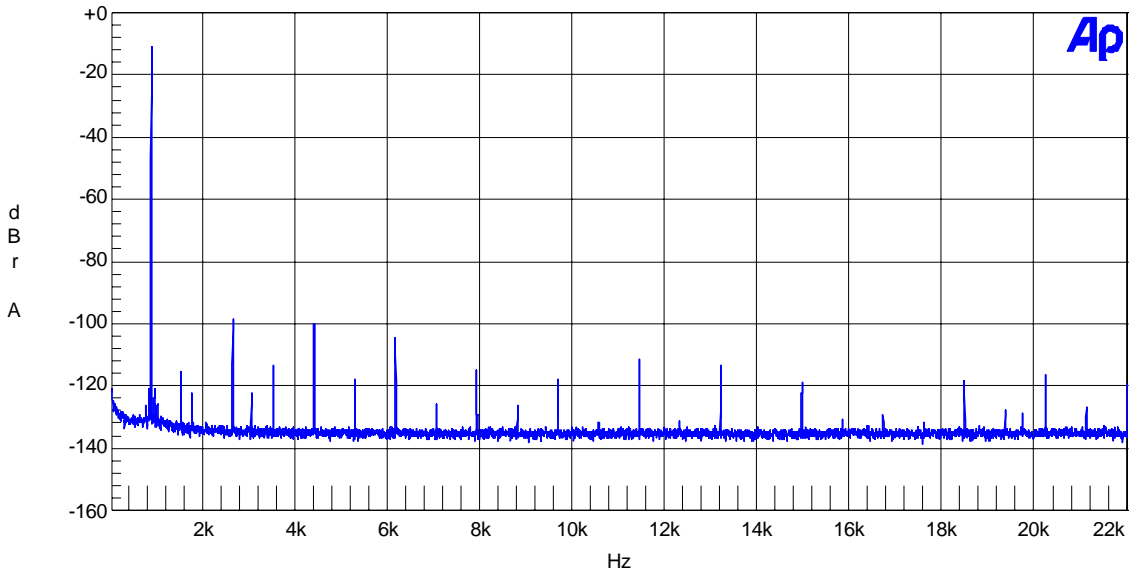

Figure 12, Setup 2 FFT on Ch1 500ASP: 0db = 500W @ 4 Ohm

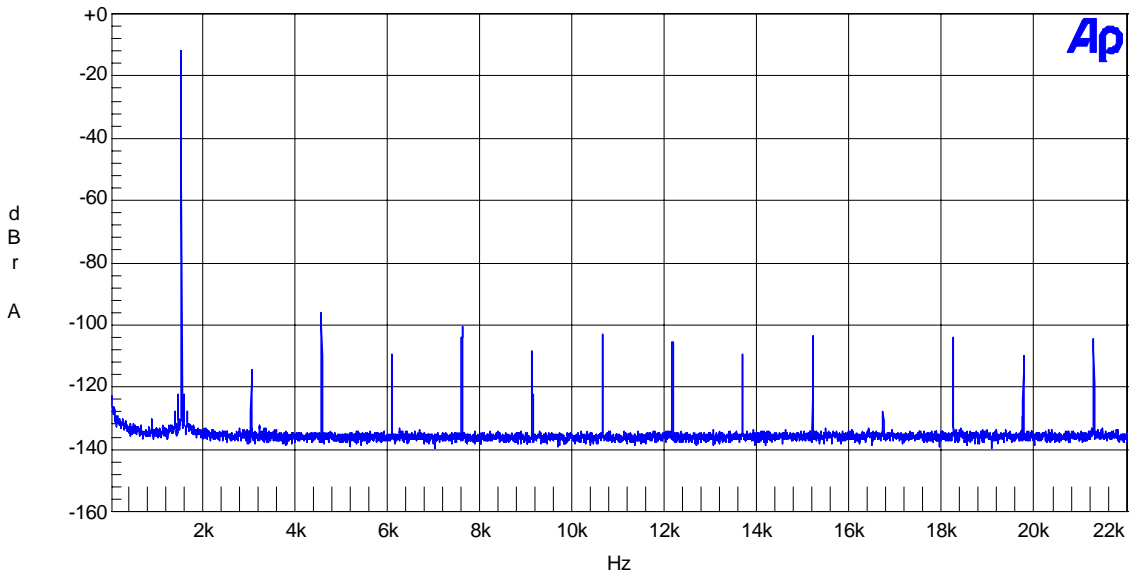

Figure 13, Setup 2 FFT on Ch2 250ASP: 0db = 200 W @ 4 Ohm

*Crosstalk vs. frequency*

The module is swept at 1/8th of rated power. 0 dB = 1/8th of rated power

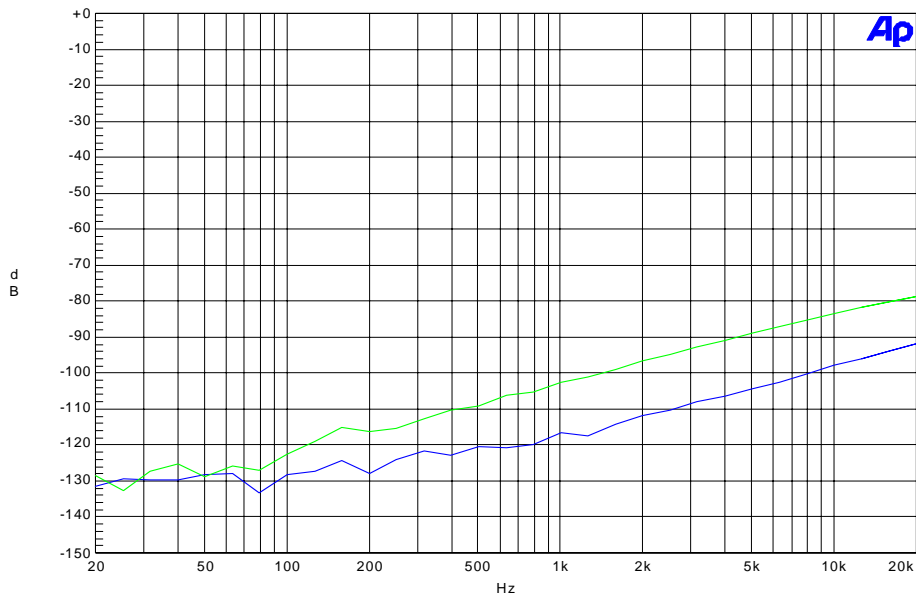

Figure 14, Setup 2 Cross talk: Ch1 500ASP to Ch2 250A and Ch2 250A to Ch1 500ASP.

*Power duration measurements*

Power duration measurements record the elapsed time after the introduction of a power step until the output is attenuated to a safe power level by the onboard protection system (Please refer to page 12 for a full description). Measurements marked with \* indicate loss of output power.

- Stepping the power load on the ASP-module

Module	Input Frequency	Preload power	Stepped power
500ASP	880 Hz	250 W @ 4Ω	500 W @ 4Ω
250A	1 kHz	250 W @ 2.7Ω	250 W @ 2.7Ω

		Power duration [ms] (t <sub>150</sub> )	
		500ASP	250A
50 Volt bus without extra capacitor	80 Volt bus without extra capacitor	28	> 2000
50 Volt bus without extra capacitor	80 Volt bus with extra capacitor 9600uF	71	> 2000
50 Volt bus with extra capacitor 9400uF	80 Volt bus without extra capacitor	43	> 2000
50 Volt bus with extra capacitor 9400uF	80 Volt bus with extra capacitor 9600uF	89	> 2000

- Stepping the power load on the hanger module

Module	Input Frequency	Preload power	Stepped power
500ASP	880 Hz	500 W @ 4Ω	500 W @ 4Ω
250A	1 kHz	0 W @ 2.7Ω	250 W @ 2.7Ω

		Power duration [ms] (t <sub>150</sub> )	
		500ASP	250A
50 Volt bus without extra capacitor	80 Volt bus without extra capacitor	27	> 2000
50 Volt bus without extra capacitor	80 Volt bus with extra capacitor 9400uF	70	> 2000
50 Volt bus with extra capacitor 9400uF	80 Volt bus without extra capacitor	46	> 2000
50 Volt bus with extra capacitor 9400uF	80 Volt bus with extra capacitor 9400uF	92	> 2000

**Setup 3: 500ASP with 500A and 250A hangers**

AP channel	Amplifier	Switching frequency	AP output	Load
Ch1	500ASP	531 kHz	AP1 bal GND	4 Ohm
Ch2	500A	494 kHz	AP2 bal GND	4 Ohm
Ch3	250A	441 kHz	GND @ AP	2.7 Ohm

Note: An aluminum shield is mounted between the two hanger modules.

*THD+N vs. Power*

Standard Power Sweep one module at a time.

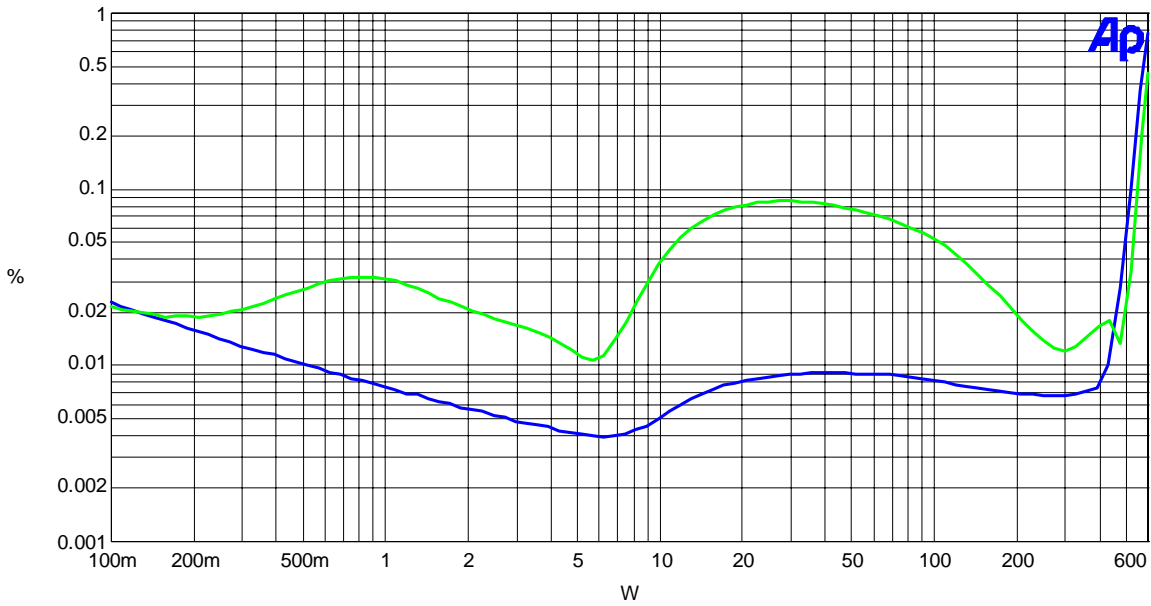

Figure 15, Setup 3 THD+N Ch1: 500ASP 1kHz and 6.66kHz

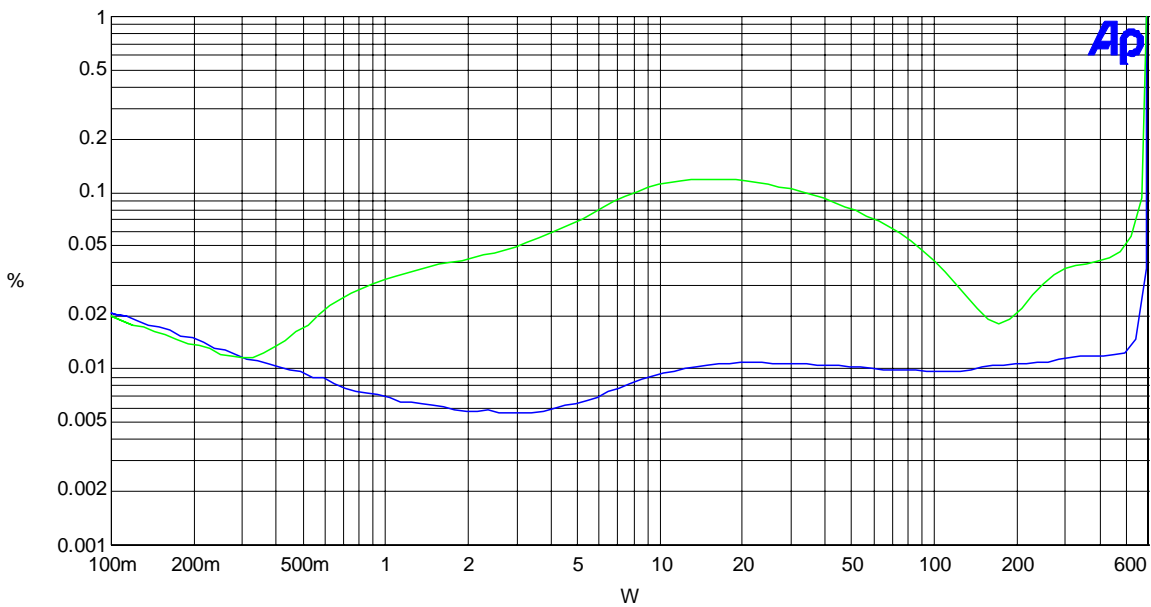

Figure 16, Setup 3 THD+N Ch2: 500A 1kHz and 6.66kHz

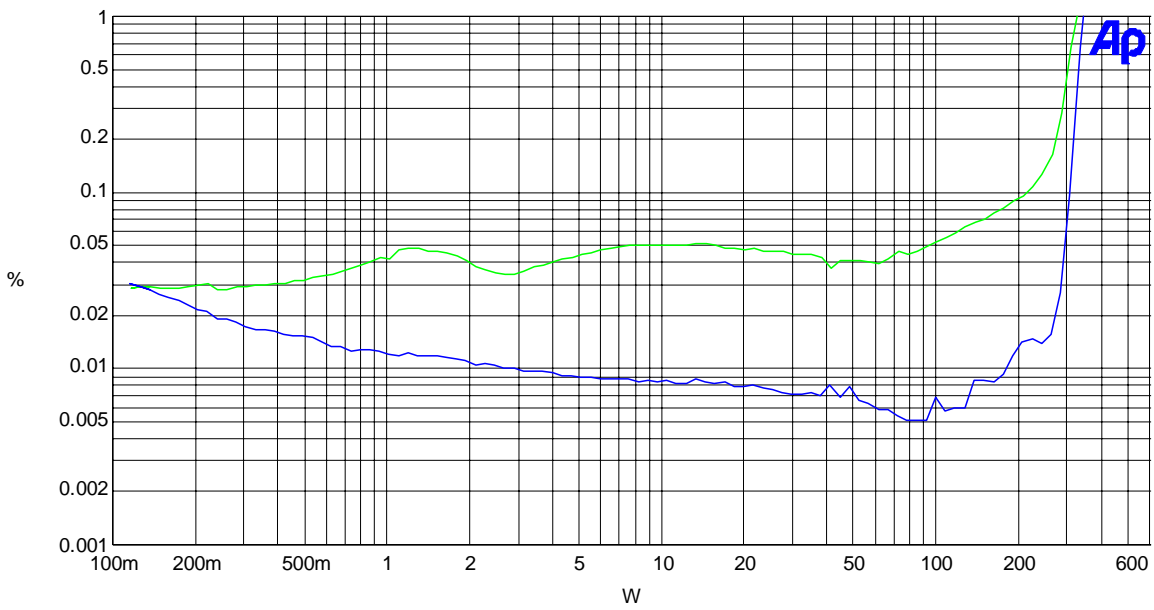

Figure 17, Setup 3 THD+N Ch3: 250A 1kHz and 6.66kHz

*Spurious*

Idle tone test

FFT on all modules without input

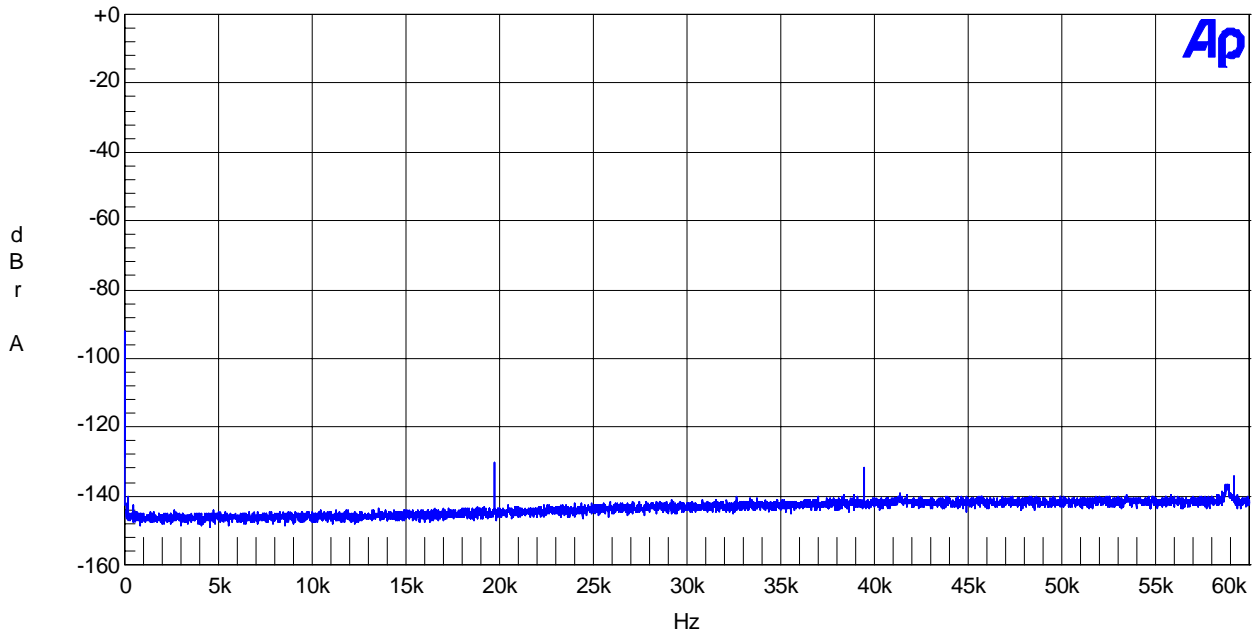

Figure 18, Setup 3 Ch1: 500ASP idle, 0db = 500W @ 4 Ohm

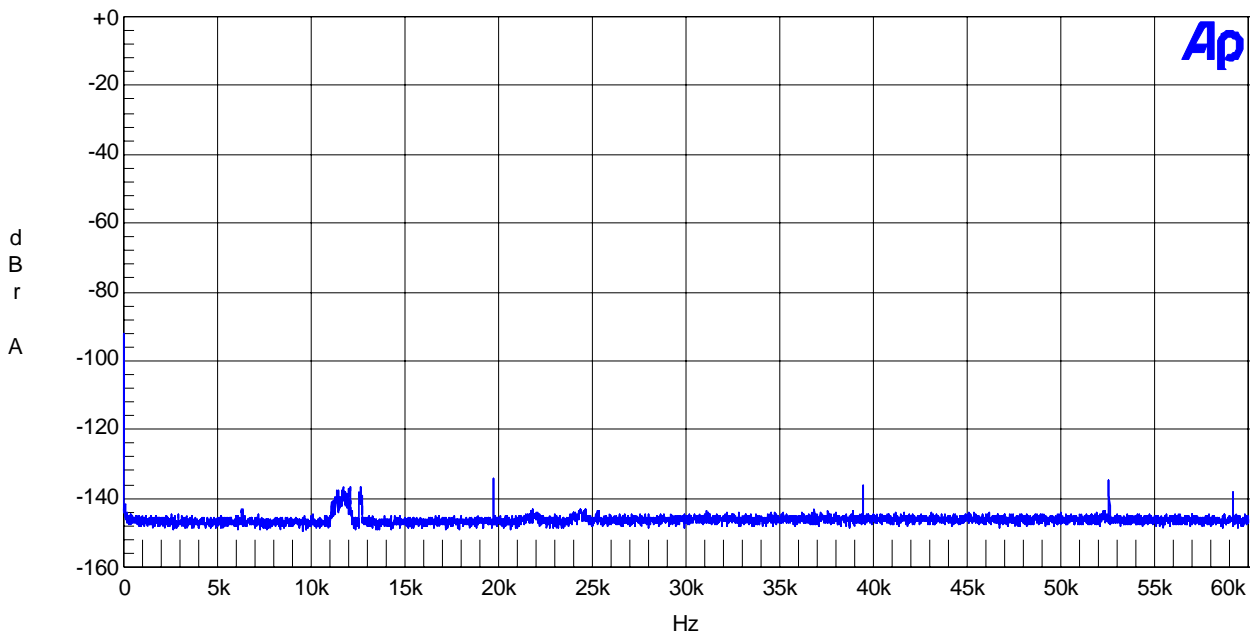

Figure 19, Setup 3 Ch2: 500A idle, 0db = 500W @ 4 Ohm

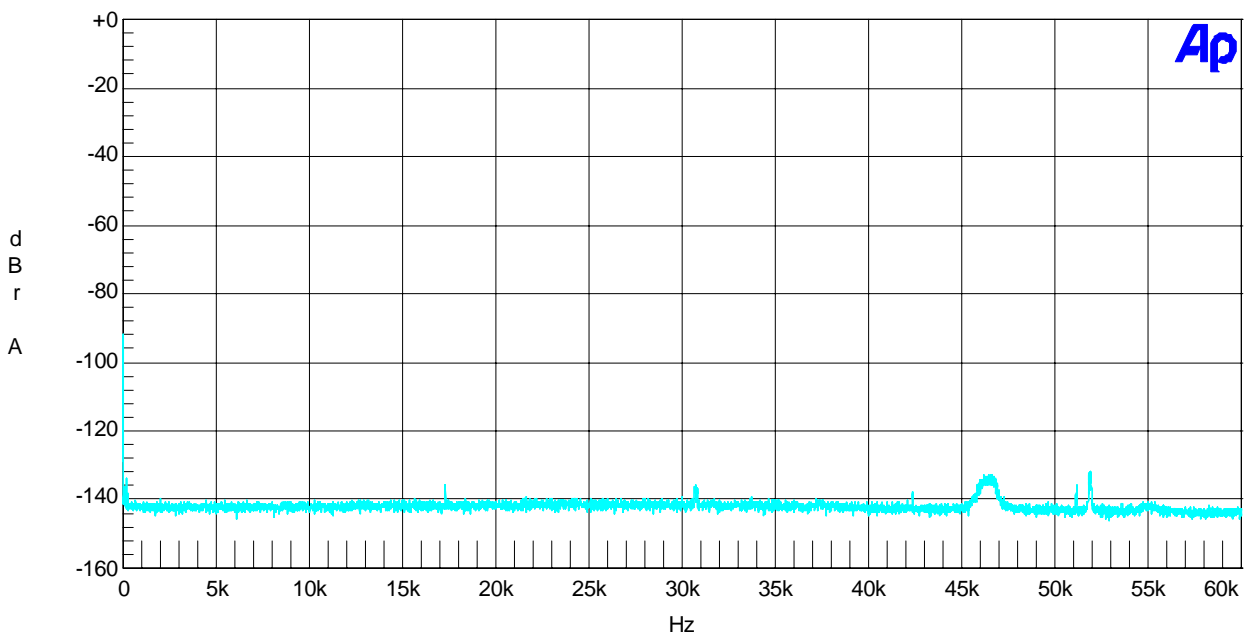

Figure 20, Setup 3 Ch3: 250A idle, 0db = 200W @ 4 Ohm

*Dynamic range and cross modulation test*

All modules at 1/8th of full power rating with sinusoidal test tones.

Test tones 880 Hz, 1.52 kHz, 2.64 kHz

FFT on all modules

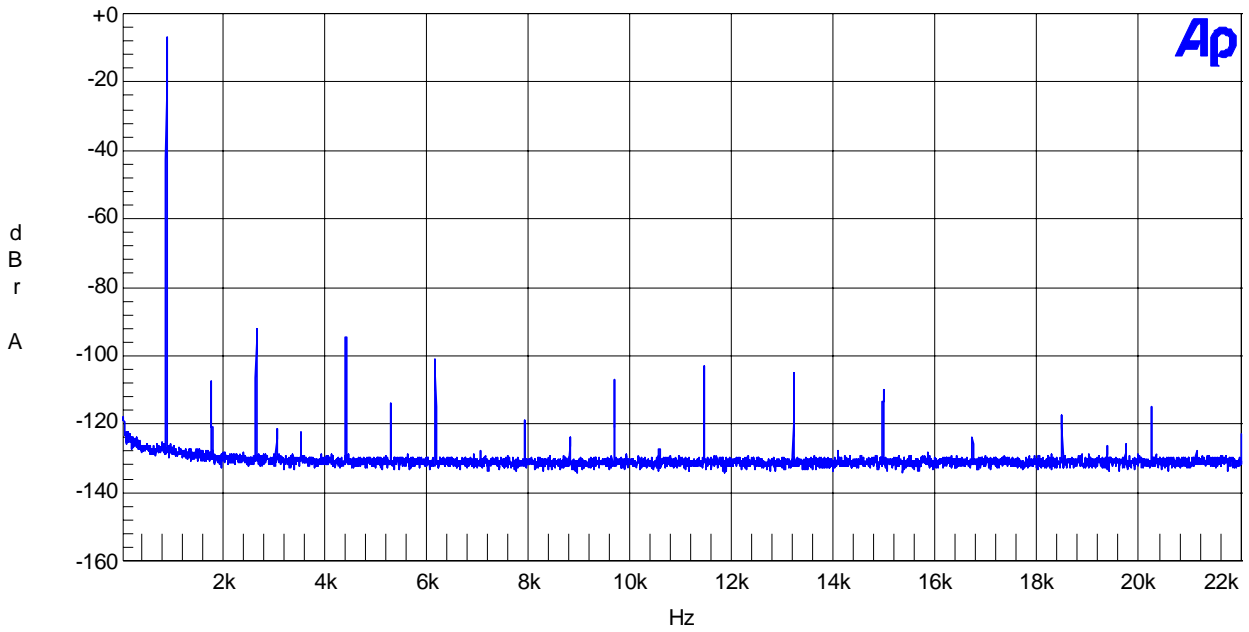

Figure 21, Setup 3 FFT on Ch1 500ASP: 0dB = 500W @ 4 Ohm

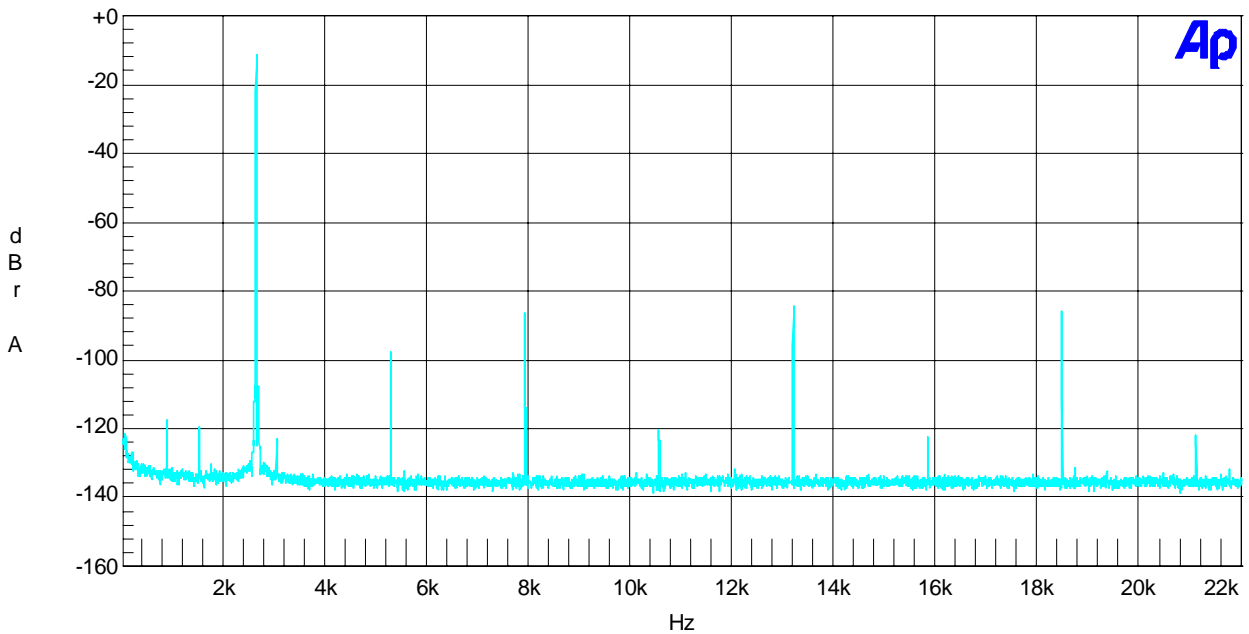

Figure 22, Setup 3 FFT on Ch2 500A: 0dB = 500W @ 4 Ohm



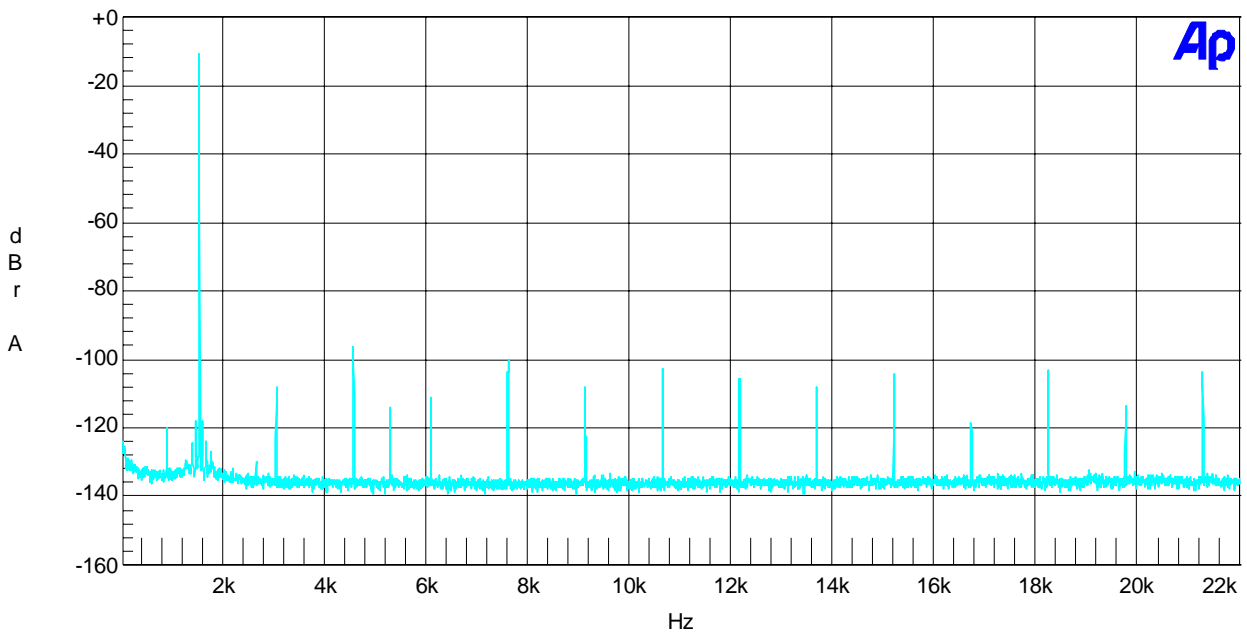

Figure 23, Setup 3 FFT on Ch3 250A: 0dB = 200W @ 4 Ohm

*Crosstalk vs. frequency*

Measurements on all unloaded modules.

The module is swept at 1/8th of rated power:

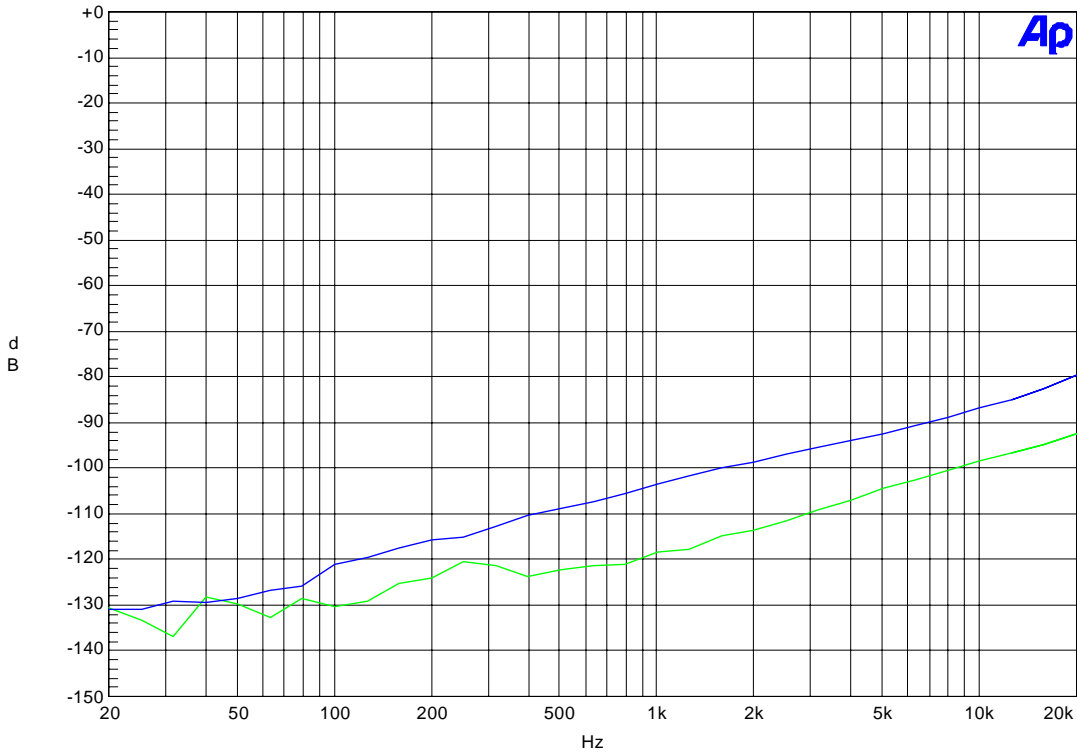

Figure 24, Setup 3 Cross talk: Ch1 500ASP to Ch2 500A and Ch2 500A to Ch1 500ASP.

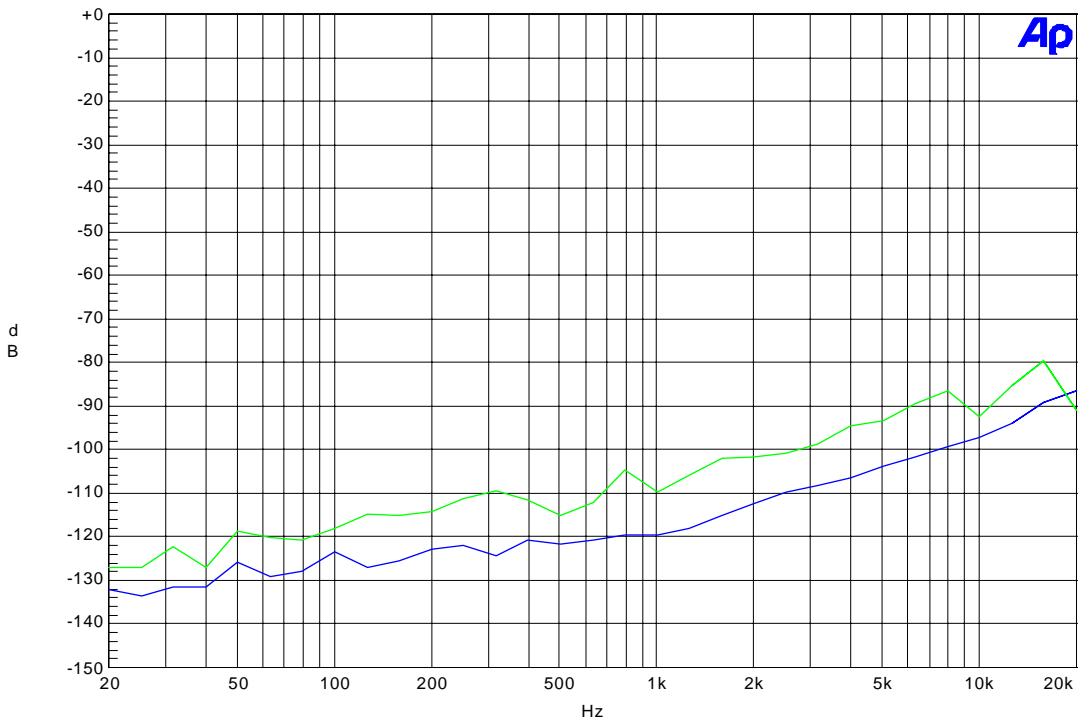

Figure 25, Setup 3 Cross talk: Ch2 500A to Ch1 500ASP and Ch2 500A to Ch3 250A.

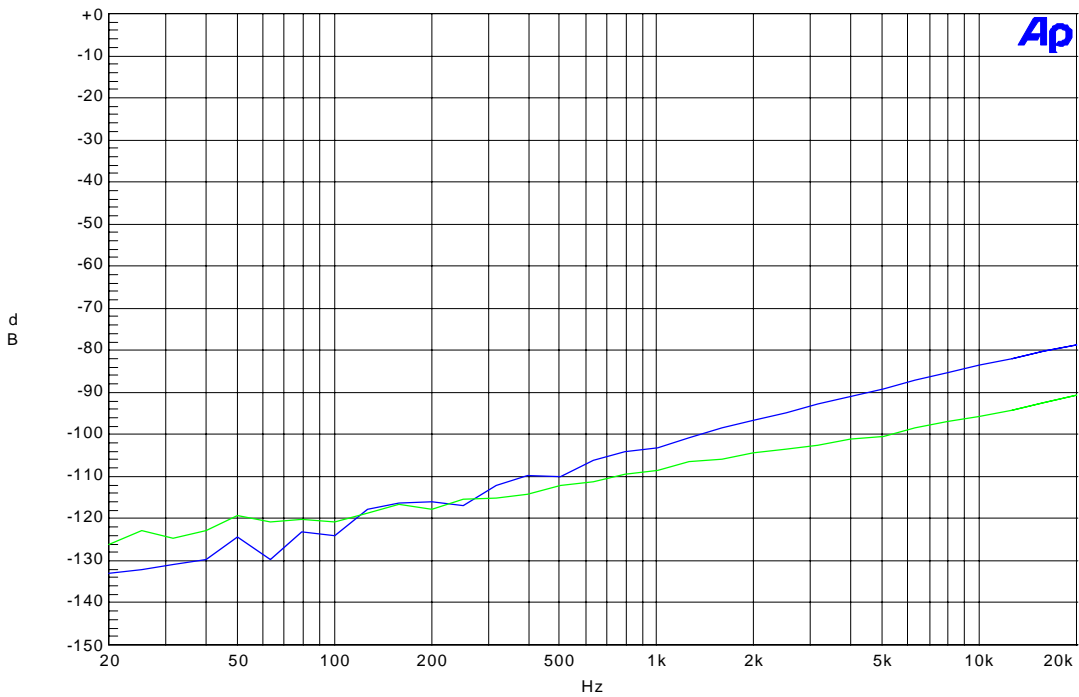

Figure 26, Setup 3 Cross talk: Ch3 250A to Ch1 500ASP and Ch3 250A to Ch2 500A.

*Power duration measurements*

Power duration measurements record the elapsed time after the introduction of a power step until the output is attenuated to a safe power level by the onboard protection system (Please refer to page 12 for a full description). Measurements marked with \* indicate loss of output power.

- Stepping the power load on the ASP-module

Module	Input Frequency	Preload power	Stepped power
500ASP	880 Hz	250 W @ 4Ω	500 W @ 4Ω
500A	1.52 kHz	125 W @ 4Ω	125 W @ 4Ω
250A	1 kHz	125 W @ 2.7Ω	125 W @ 2.7Ω

		Power duration [ms] (t <sub>150</sub> )		
		500ASP	500A	250A
50 Volt bus w/o extra capacitor	80 Volt bus w/o extra capacitor	33	> 2000	> 2000
50 Volt bus w/o extra capacitor	80 Volt bus with extra capacitor 9600uF	80	> 2000	> 2000
50 Volt bus with extra capacitor 9600uF	80 Volt bus w/o extra capacitor	51	> 2000	> 2000
50 Volt bus with extra capacitor 9600uF	80 Volt bus with extra capacitor 9600uF	97	> 2000	> 2000

- Stepping the power load on the 500A hanger module

Module	Input Frequency	Preload power	Stepped power
500ASP	880 Hz	125 W @ 4Ω	125 W @ 4Ω
500A	1.52 kHz	250 W @ 4Ω	500 W @ 4Ω
250A	1 kHz	125 W @ 2.7Ω	125 W @ 2.7Ω

		Power duration [ms] (t <sub>150</sub> )		
		500ASP	500A	250A
50 Volt bus w/o extra capacitor	80 Volt bus w/o extra capacitor	36*	36	1000*
50 Volt bus w/o extra capacitor	80 Volt bus with extra capacitor 9600uF	89*	80	169*
50 Volt bus with extra capacitor 9600uF	80 Volt bus w/o extra capacitor	57*	52	404*
50 Volt bus with extra capacitor 9600uF	80 Volt bus with extra capacitor 9600uF	108*	98	143

- Stepping the power load on the 250A hanger module

Module	Input Frequency	Preload power	Stepped power
500ASP	880 Hz	250 W @ 4Ω	250 W @ 4Ω
500A	1.52 kHz	250 W @ 4Ω	250 W @ 4Ω
250A	1 kHz	0 W @ 2.7Ω	250 W@2.7Ω

		Power duration [ms] (t <sub>150</sub> )		
		500ASP	500A	250A
50 Volt bus w/o extra capacitor	80 Volt bus w/o extra capacitor	32	> 2000	83*
50 Volt bus w/o extra capacitor	80 Volt bus with extra capacitor 9600uF	79	> 2000	250*
50 Volt bus with extra capacitor 9600uF	80 Volt bus w/o extra capacitor	50	> 2000	150*
50 Volt bus with extra capacitor 9600uF	80 Volt bus with extra capacitor 9600uF	96	> 2000	156*

**Setup 4: 500ASP with 250A and 250A hangers**

AP channel	Amplifier	Switching frequency	AP output	Load
Ch1	500ASP	431 kHz	AP1 bal GND	4 Ohm
Ch2	250A	442 kHz	AP2 bal GND	4 Ohm
Ch3	250A	444 kHz	GND @ AP	4 Ohm

THD+N vs. power

Standard Power Sweep one module at a time.

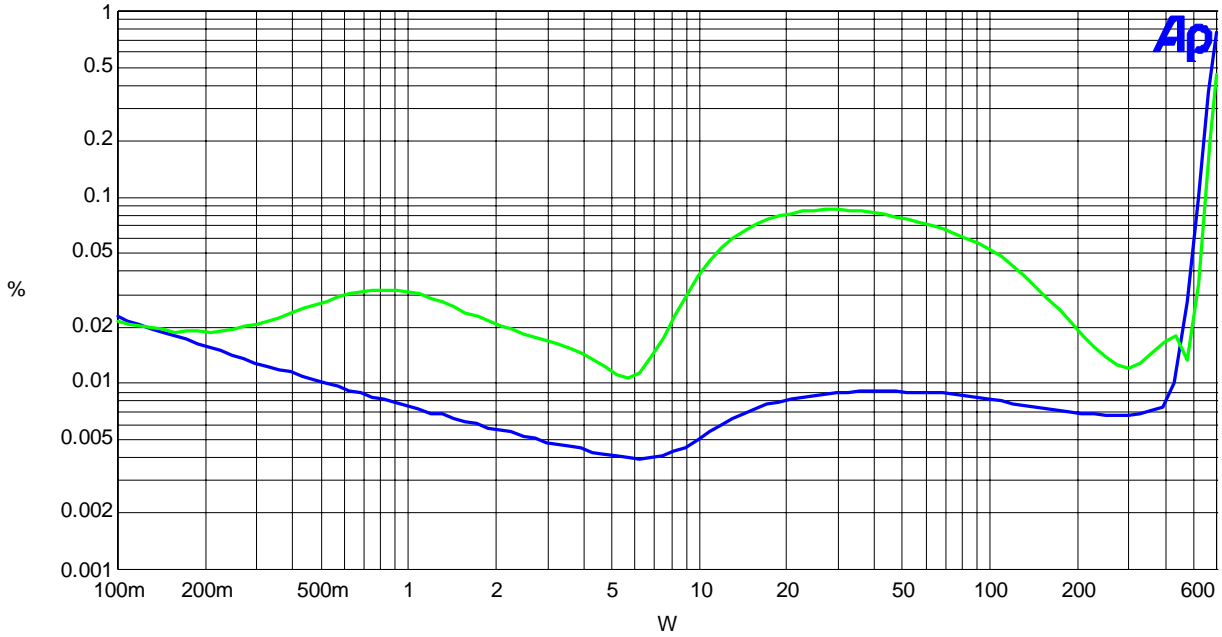

Figure 27, Setup 4 THD+N Ch1 500ASP 1kHz and 6.66kHz.

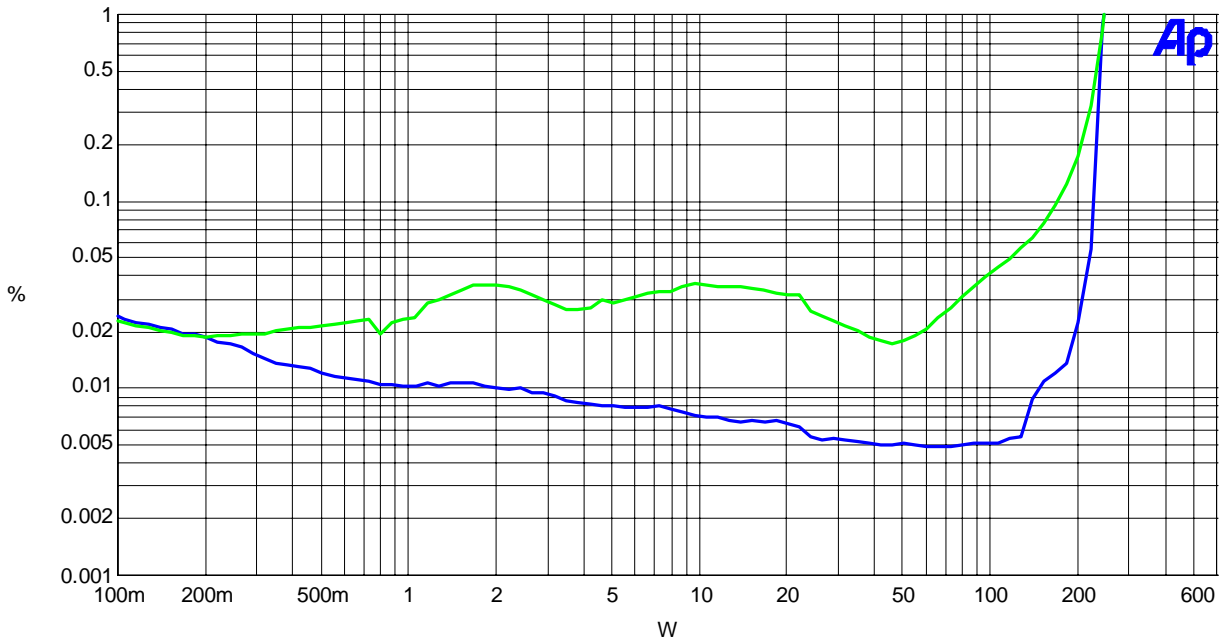

Figure 28, Setup 4 THD+N Ch2 250A 1kHz and 6.66kHz.

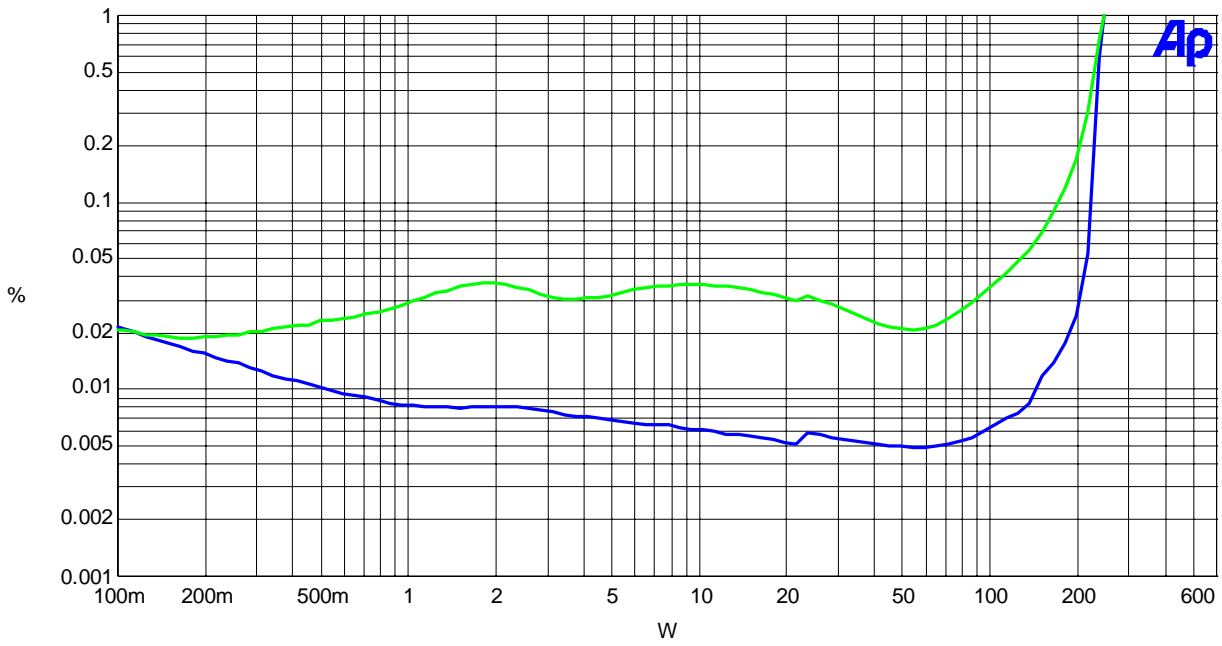

Figure 29, Setup 4 THD+N Ch3 250A 1kHz and 6.66kHz.

*Spurious*

Spurious at idle

FFT on all modules without input

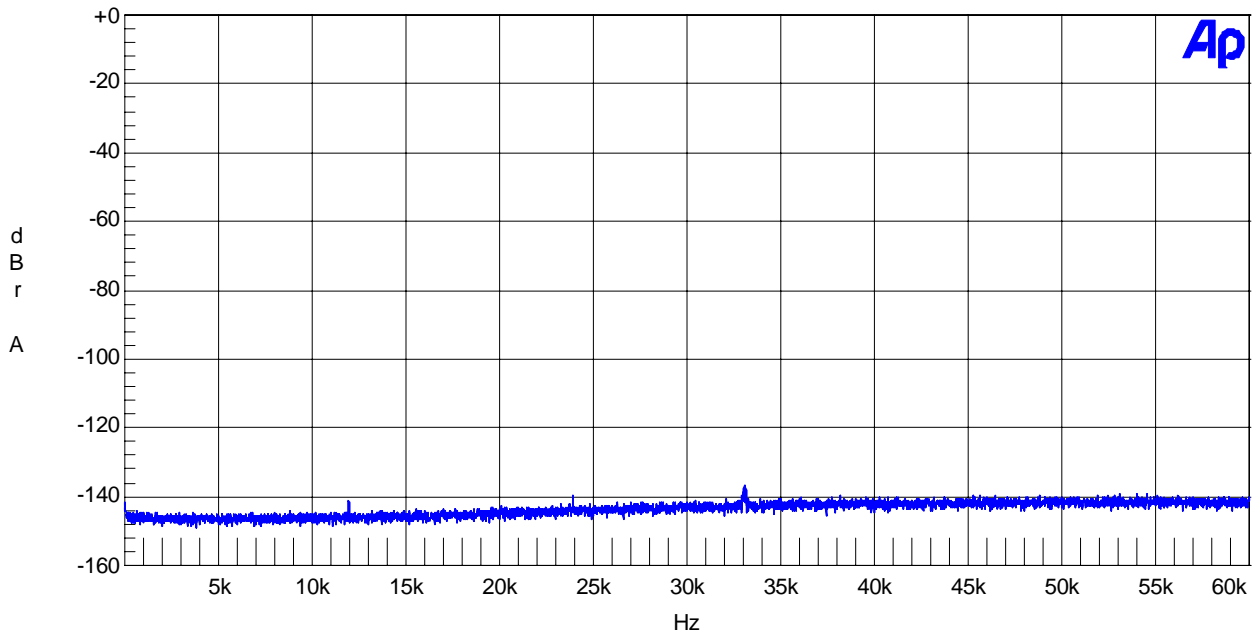

Figure 30, Setup 4 Ch1: 500ASP idle, 0db = 500W @ 4 Ohm

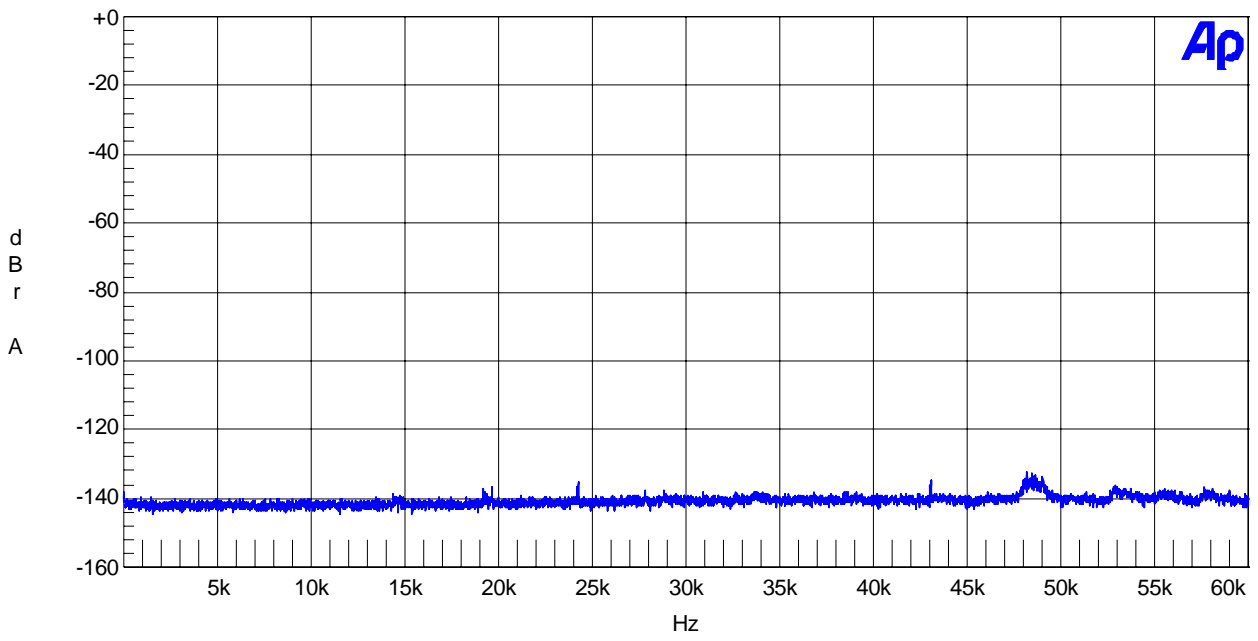

Figure 31, Setup 4 Ch2: 250A idle, 0db = 200W @ 4 Ohm

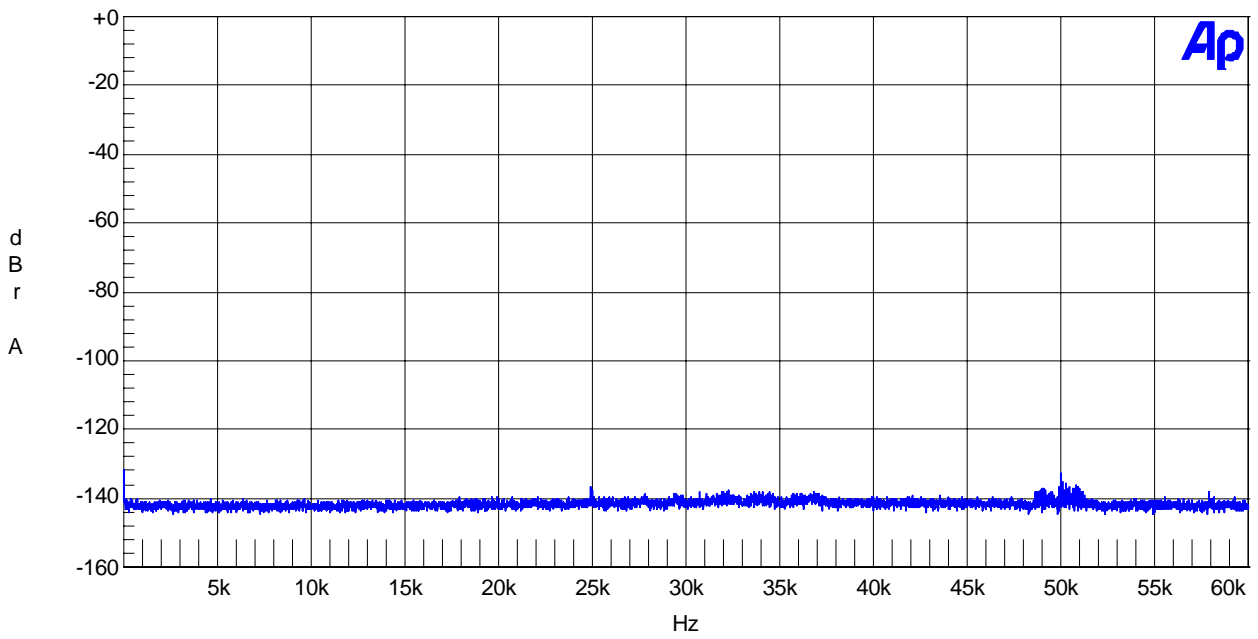

Figure 32, Setup 4 Ch3: 250A idle, 0db = 200W @ 4 Ohm

*Dynamic range and cross modulation test*

All modules at 1/8 of full power rating with sinusoidal test tones.

Test tones 880 Hz, 1.52 kHz, 2.64 kHz.

FFT on all modules

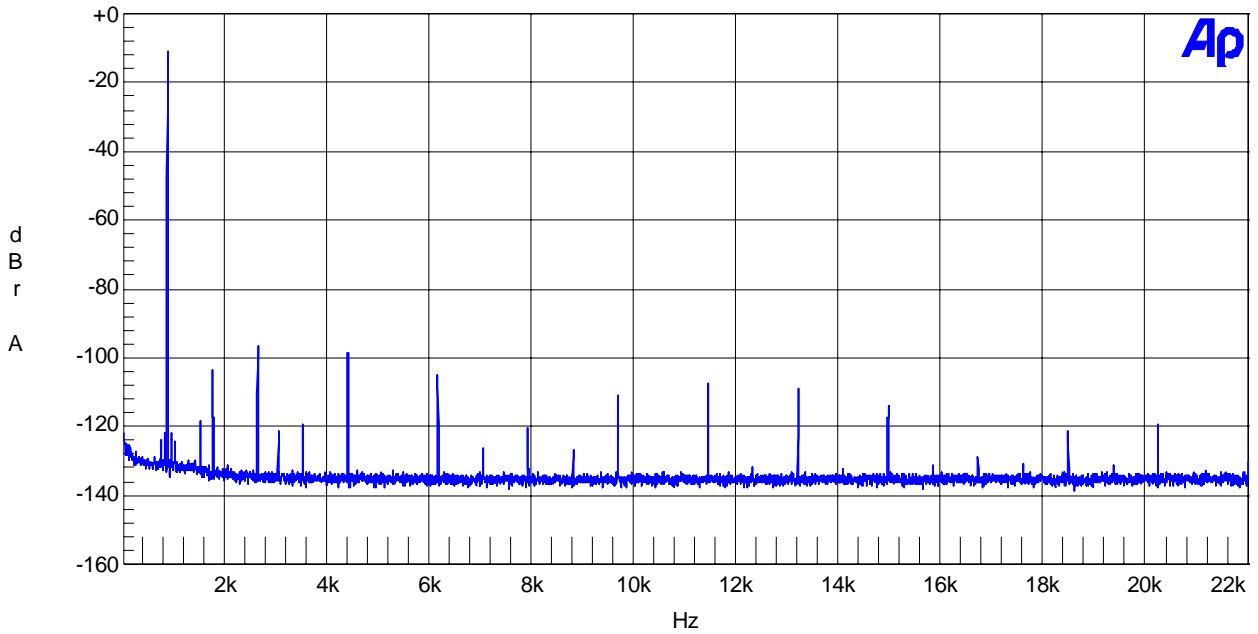

Figure 33, Setup 4 FFT on Ch1 500ASP: 0dB = 500W @ 4 Ohm

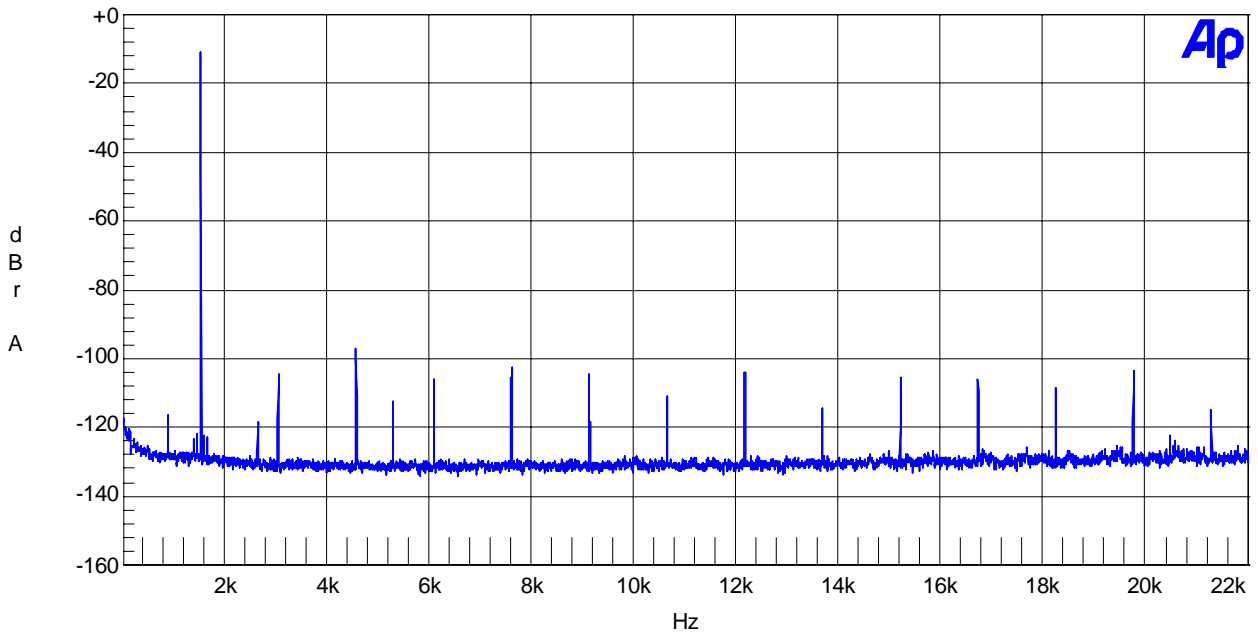

Figure 34, Setup 4 FFT on Ch2 250A: 0dB = 200W @ 4 Ohm

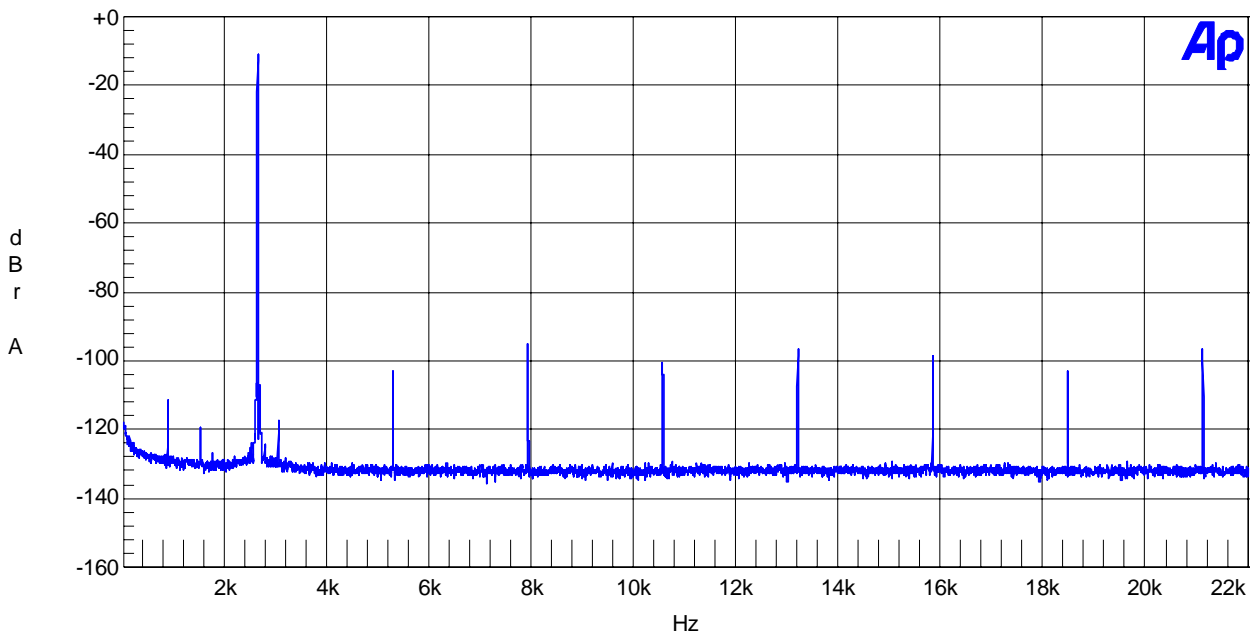

Figure 35, Setup 4 FFT on Ch3 250A: 0dB = 200W @ 4 Ohm

*Crosstalk vs. frequency*

Measurements on all unloaded modules.  
The module is swept at 1/8th of rated power.

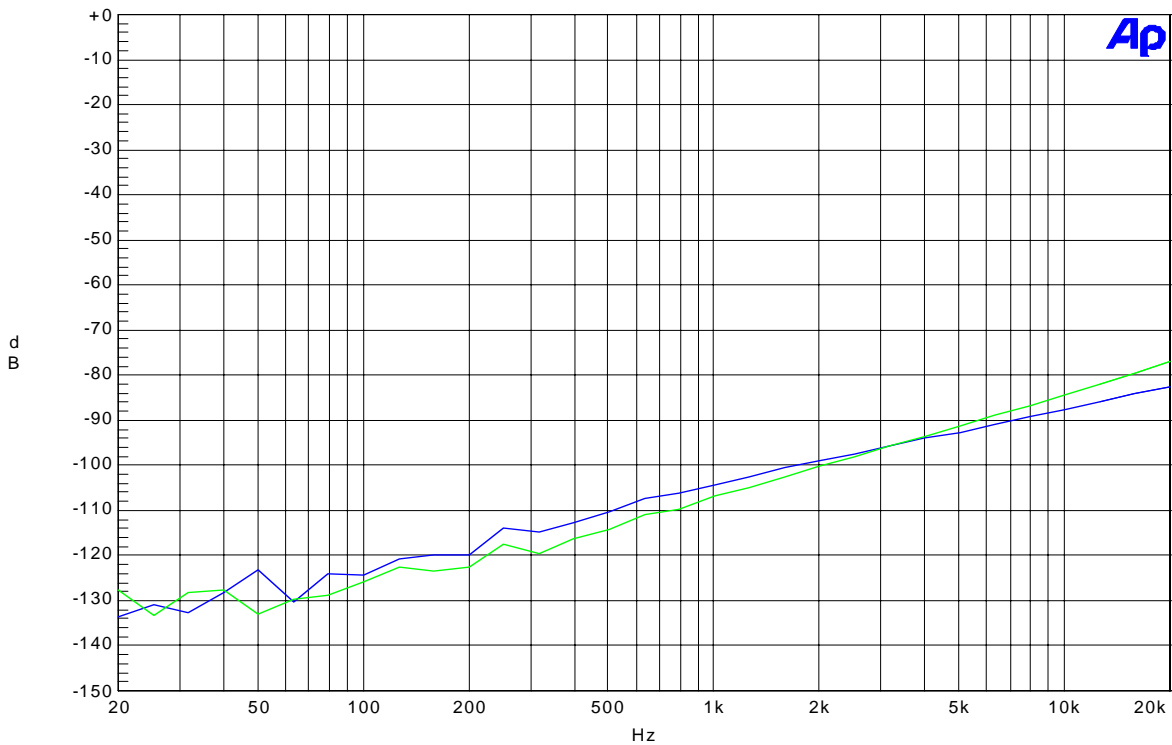

Figure 36, Setup 4 Cross talk: Ch1 500ASP to Ch2 250A and Ch1 500ASP to Ch3 250A.



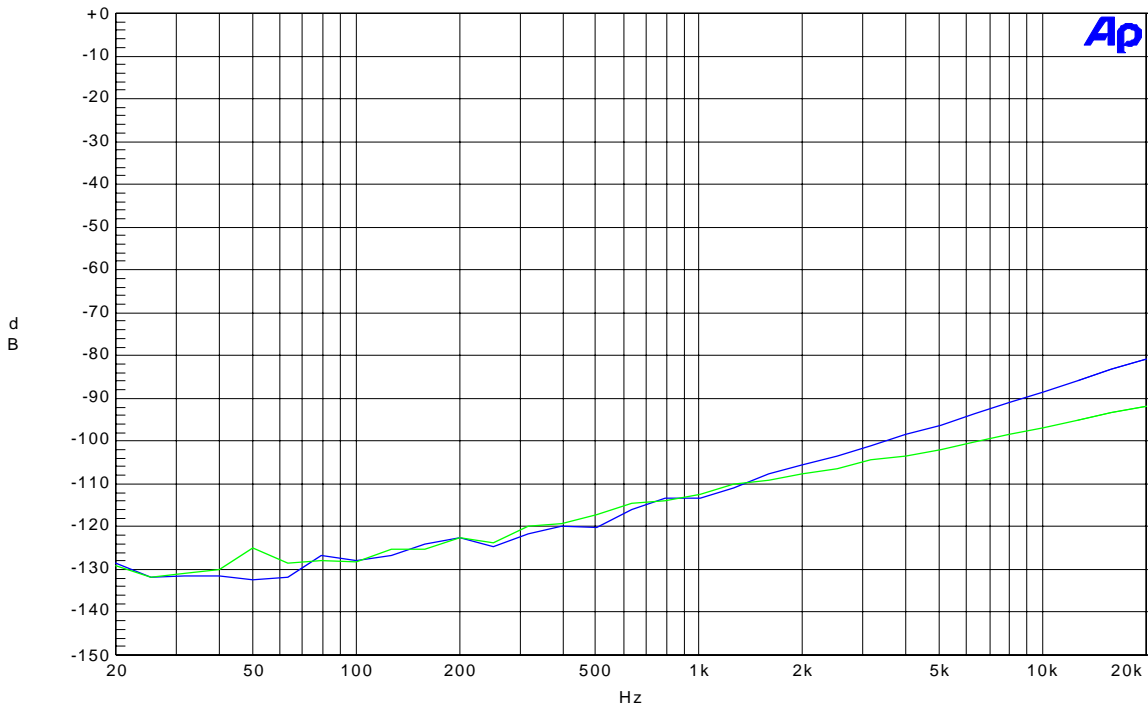

Figure 37, Setup 4 Cross talk: Ch2 250A to Ch1 500ASP and Ch2 250A to Ch3 250A.

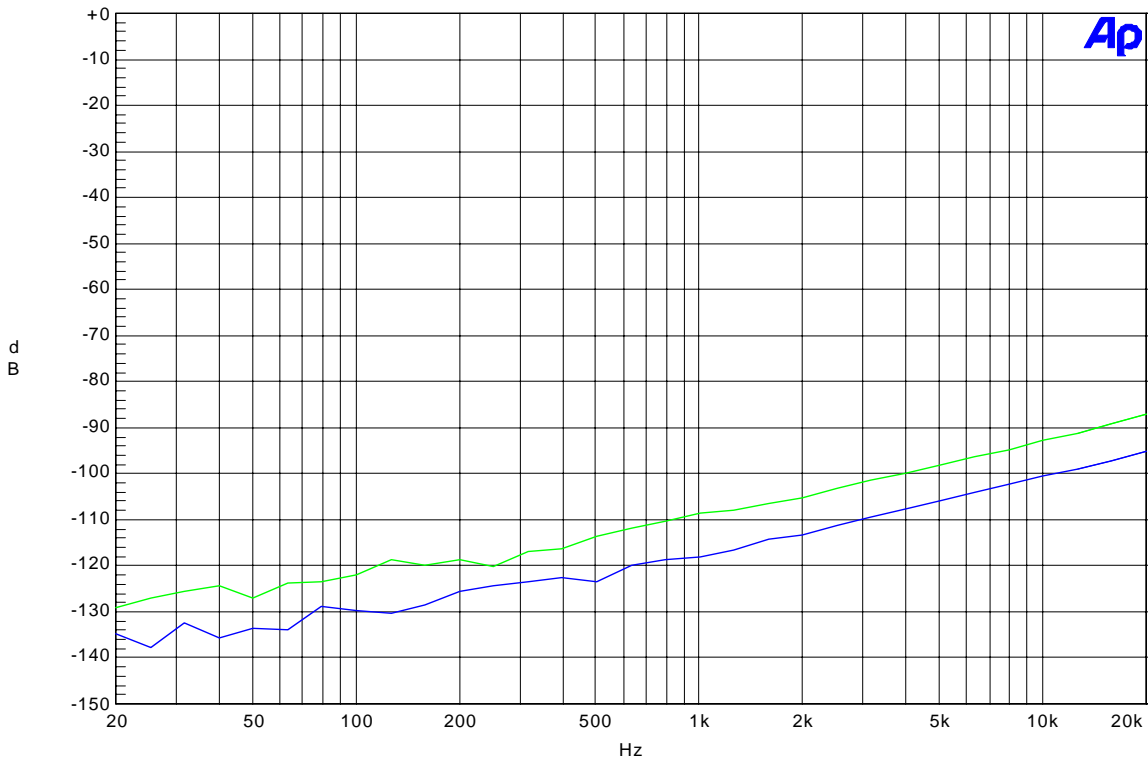

Figure 38, Setup 4 Cross talk: Ch3 250A to Ch1 500ASP and Ch3 250A to Ch2 250A.

*Power duration measurements*

Power duration measurements record the elapsed time after the introduction of a power step until the output is attenuated to a safe power level by the onboard protection system (Please refer to page 12 for a full description). Measurements marked with \* indicate loss of output power.

- Stepping the power load on the ASP-module

Module	Input Frequency	Preload power	Stepped power
500ASP	880 Hz	250 W @ 4Ω	500 W@4Ω
250A <sub>1</sub>	1.52 kHz	125 W @ 2.7Ω	125 W @ 2.7Ω
250A <sub>2</sub>	1 kHz	125 W @ 2.7Ω	125 W @ 2.7Ω

		Power duration [ms] (t <sub>150</sub> )		
		500ASP	250A <sub>1</sub>	250A <sub>2</sub>
50 Volt bus w/o extra capacitor	80 Volt bus w/o extra capacitor	29	> 2000	> 2000
50 Volt bus w/o extra capacitor	80 Volt bus with extra capacitor 9600uF	74	> 2000	> 2000
50 Volt bus with extra capacitor 9600uF	80 Volt bus w/o extra capacitor	48	> 2000	> 2000
50 Volt bus with extra capacitor 9600uF	80 Volt bus with extra capacitor 9600uF	93	> 2000	> 2000

- Stepping the power load on a hanger module

Module	Input Frequency	Preload power	Stepped power
500ASP	880 Hz	250 W @ 4Ω	250 W @ 4Ω
250A <sub>1</sub>	1.52 kHz	250 W @ 2.7Ω	250 W @ 2.7Ω
250A <sub>2</sub>	1 kHz	0 W @ 2.7Ω	250 W @ 2.7Ω

		Power duration [ms] (t <sub>150</sub> )		
		500ASP	250A <sub>1</sub>	250A <sub>2</sub>
50 Volt bus w/o extra capacitor	80 Volt bus w/o extra capacitor	27	1093*	39
50 Volt bus w/o extra capacitor	80 Volt bus with extra capacitor 9600uF	63	330*	1330*
50 Volt bus with extra capacitor 9600uF	80 Volt bus w/o extra capacitor	45	364*	> 2000
50 Volt bus with extra capacitor 9600uF	80 Volt bus with extra capacitor 9600uF	80	708*	> 2000

**Setup 5: 1000ASP with 500A hanger**

AP channel	Amplifier	Switching frequency	AP output	Load
Ch1	1000ASP	358 kHz	AP1 bal GND	4 Ohm
Ch2	500A	465 kHz	AP2 bal GND	4 Ohm

THD+N vs. power

Power Sweep one module at a time.

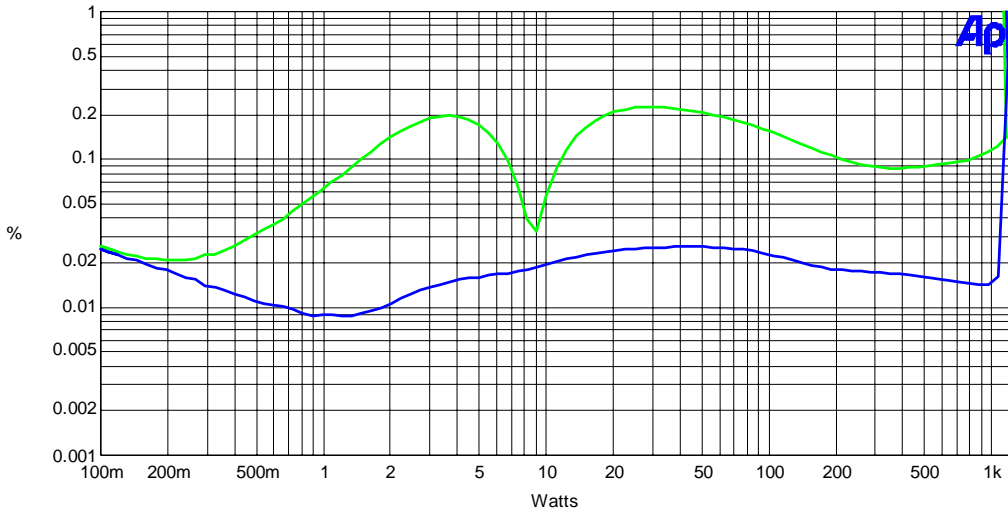

Figure 39, Setup 5 THD+N vs. power Ch1: 1000ASP 1kHz and 6.66kHz

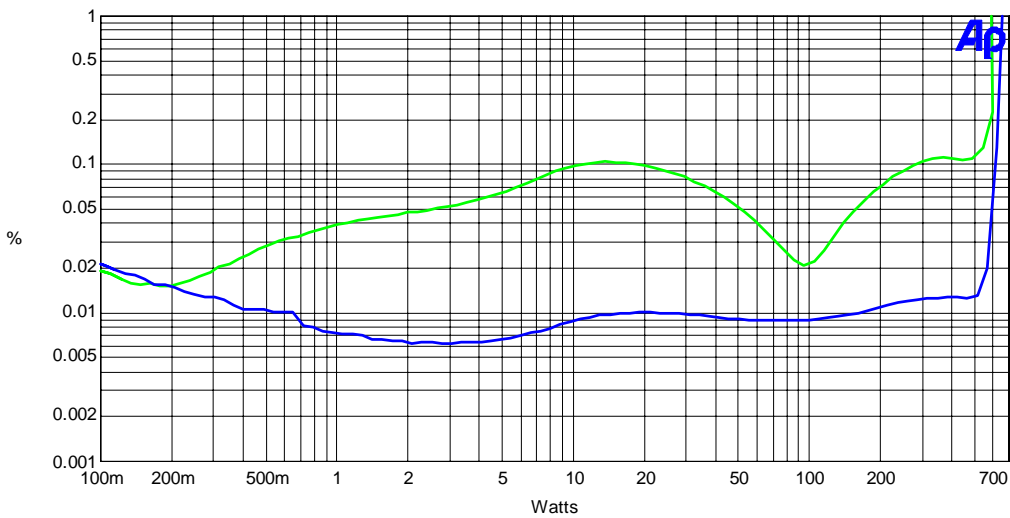

Figure 40, Setup 5 THD+N vs. power Ch2: 500A 1kHz and 6.66kHz

*Spurious*

Spurious at idle.

FFT on both modules without input

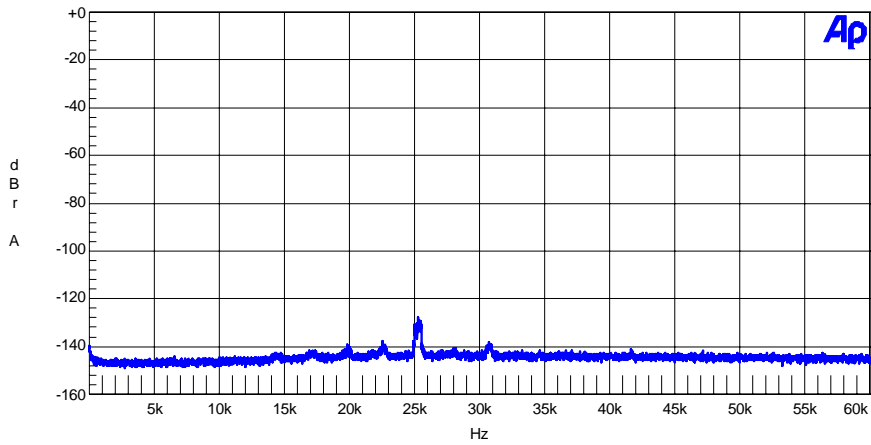

Figure 41, Setup 5 Ch1: 1000ASP idle, 0db = 1000W @ 4 Ohm

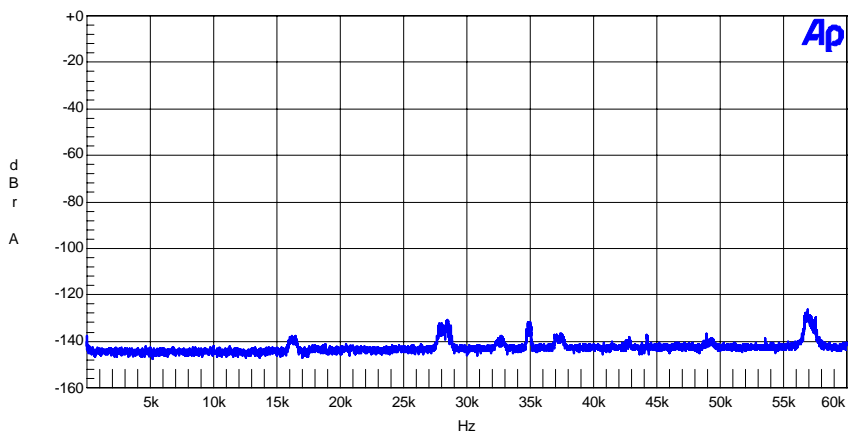

Figure 42, Setup 5 Ch2: 500A idle, 0db = 500W @ 4 Ohm

*Dynamic range and cross modulation test*

Both modules at 1/8th of full power rating with sinusoidal test tones.

Test tones Ch1: 880 Hz and Ch2 1.52 kHz

FFT on both modules

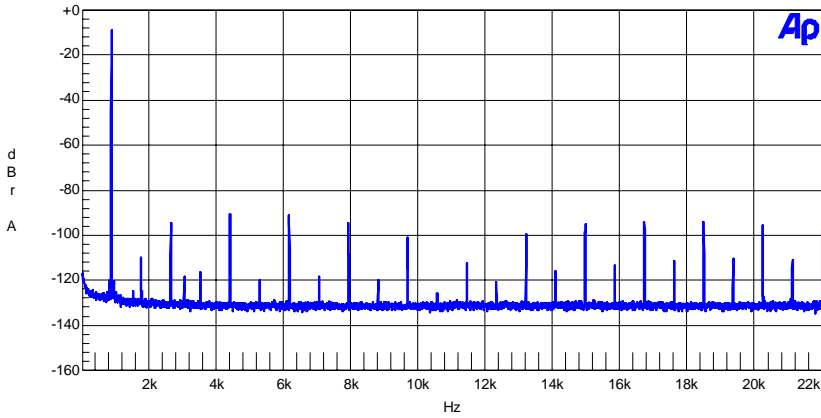

Figure 43, Setup 5 FFT on Ch1 1000ASP: 0db = 1000W @ 4 Ohm

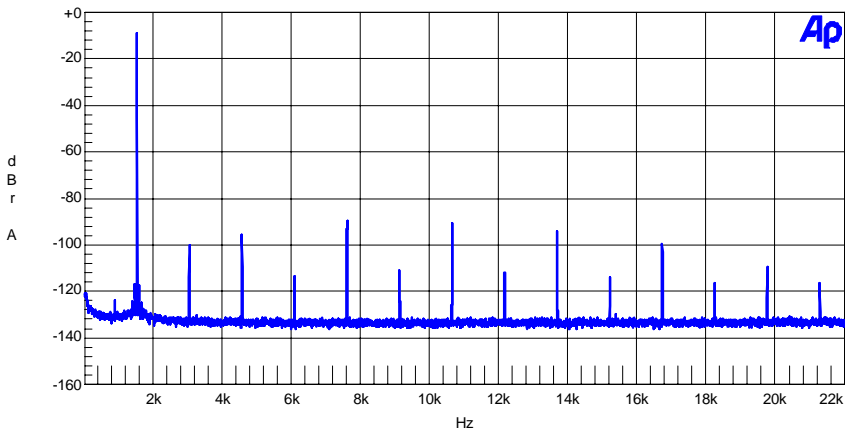

Figure 44, Setup 5 FFT on Ch2 500A: 0db = 500W @ 4 Ohm

*Crosstalk vs. frequency*

The module is swept at 1/8th of rated power. 0 dB = 1/8th rated power

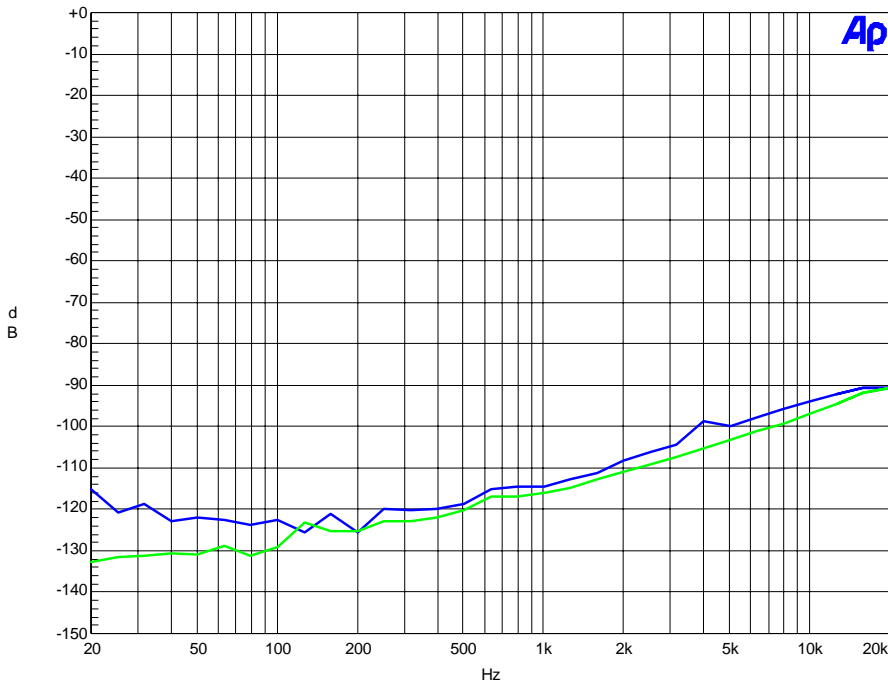

Figure 45, Setup 5 Cross talk: Ch1 1000ASP to Ch2 500A and Ch2 500A to Ch1 1000ASP.

*Power duration measurements*

Power duration measurements record the elapsed time after the introduction of a power step until the output is attenuated to a safe power level by the onboard protection system (Please refer to page 12 for a full description). Measurements marked with \* indicate loss of output power.

- Stepping the power load on the ASP-module

Module	Input Frequency	Preload power	Stepped power
1000ASP	880 Hz	500 W @ 4 Ω	1000 W @ 4 Ω
500A	1 kHz	500 W @ 4 Ω	500 W @ 4 Ω

	Power duration [ms] (t <sub>150</sub> )	
	1000ASP	500A
80 Volt bus without extra capacitor	33	40
80 Volt bus with extra capacitor 9400 uF	55	50

- Stepping the power load on the hanger module

Module	Input Frequency	Preload power	Stepped power
1000ASP	880 Hz	1000 W @ 4 Ω	1000 W @ 4 Ω
500A	1 kHz	0 W @ 4 Ω	500 W @ 4 Ω

	Power duration [ms] (t <sub>150</sub> )	
	1000ASP	500A
80 Volt bus without extra capacitor	33	40
80 Volt bus with extra capacitor 9400 uF	55	70

**Setup 6: 1000ASP with 1000A hanger**

AP channel	Amplifier	Switching frequency	AP output	Load
Ch1	1000ASP	352 kHz	AP1 bal GND	4 Ohm
Ch2	1000A	330 kHz	AP2 bal GND	4 Ohm

**Please note!** Even though the 1000A module has limited bandwidth, ICEpower strongly recommends using the 1000ASP to power the bass driver with the hardest load. This is because the integrated protection features only protects the ASP-module itself and not the hanger modules.

*THD+N vs. power*

Power Sweep one module at a time.

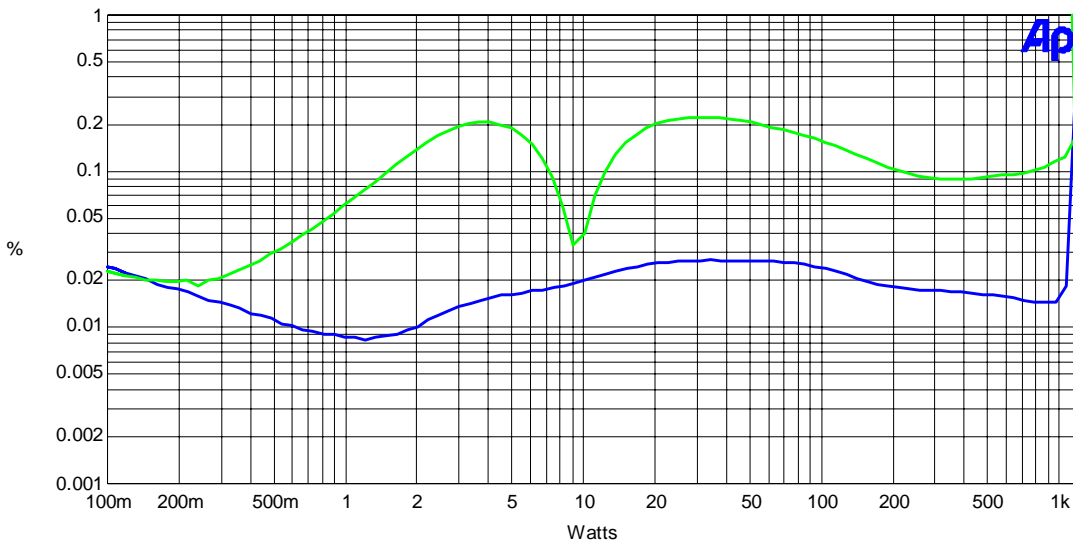

Figure 46, Setup 6 THD+N vs. power Ch1: 1000ASP 1kHz and 6.66kHz

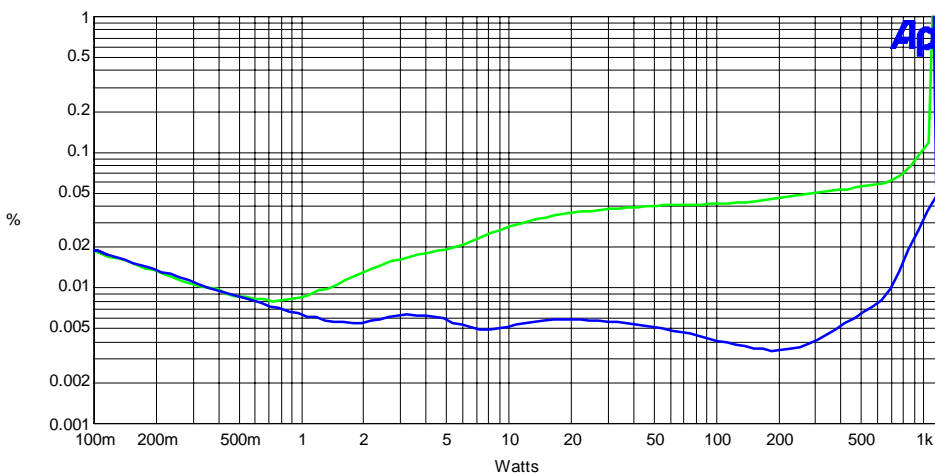

Figure 47, Setup 6 THD+N vs. power Ch2: 1000A 100Hz and 1kHz

*Spurious*

Spurious at idle.

FFT on all modules without input

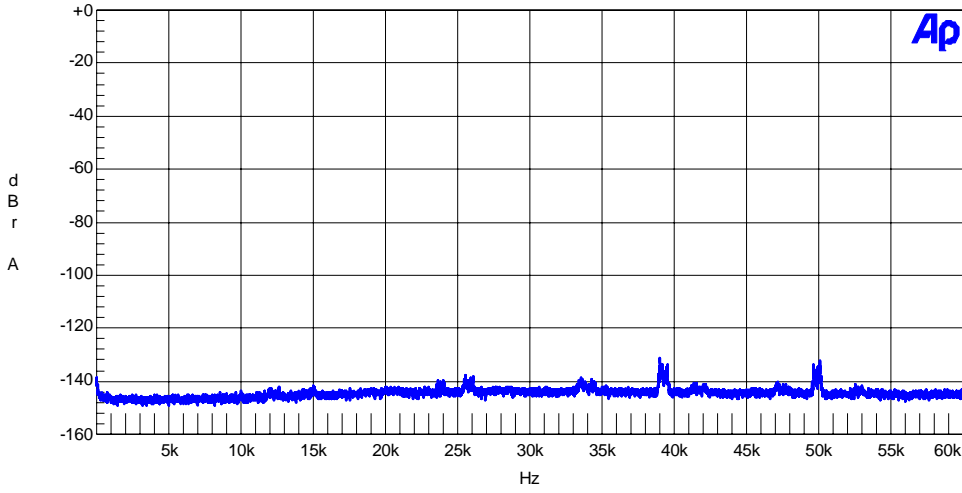

Figure 48, Setup 6 Ch1: 1000ASP idle, 0db = 1000W @ 4 Ohm

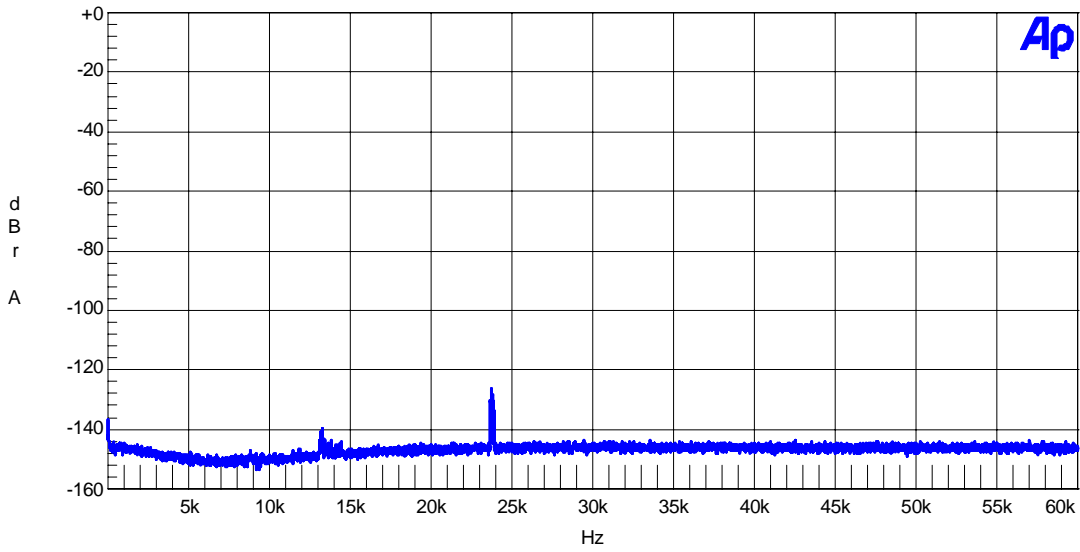

Figure 49, Setup 6 Ch2: 1000A idle, 0db = 1000W @ 4 Ohm



*Dynamic range and cross modulation test*

Both modules at 1/8th of full power rating with sinusoidal test tones.

Test tones Ch1: 880 Hz and Ch2 1.52 kHz

FFT on both modules

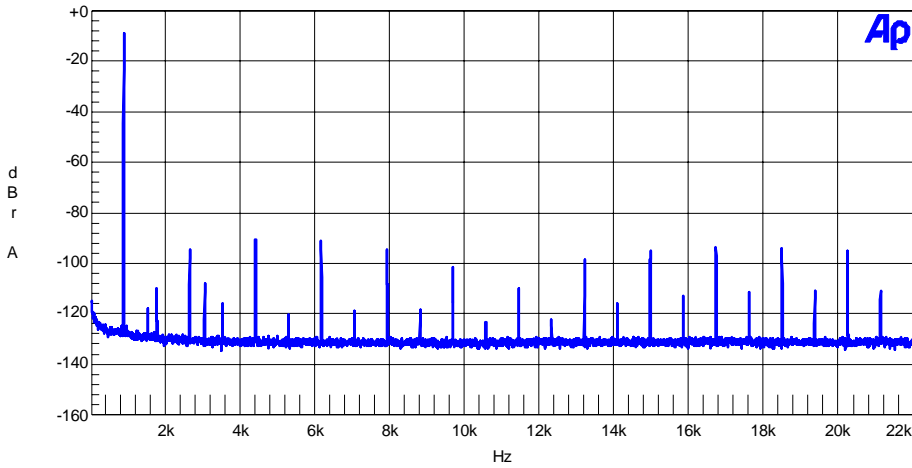

Figure 50, Setup 6 FFT on Ch1 1000ASP: 0db = 1000W @ 4 Ohm

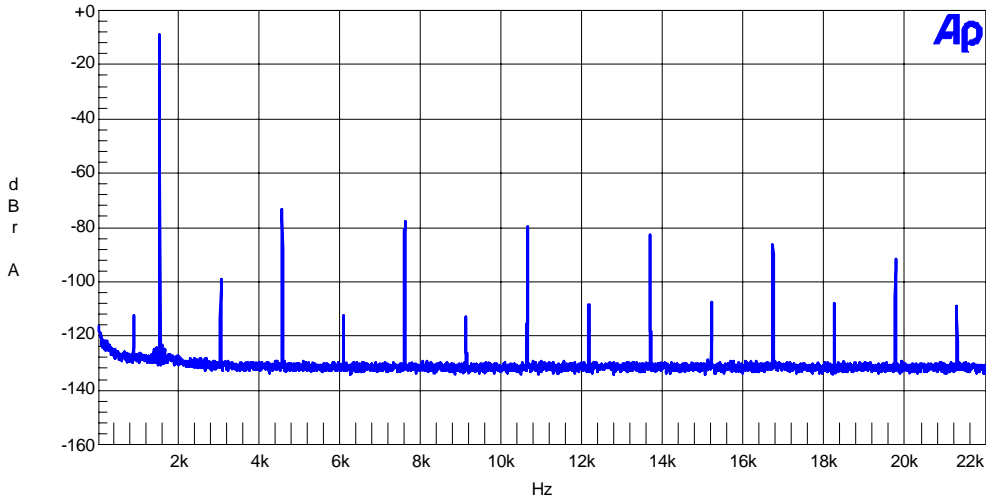

Figure 51, Setup 6 FFT on Ch2 1000A: 0db = 1000W @ 4 Ohm

*Crosstalk vs. frequency*

The module is swept at 1/8th of rated power. 0 dB = 1/8th rated power

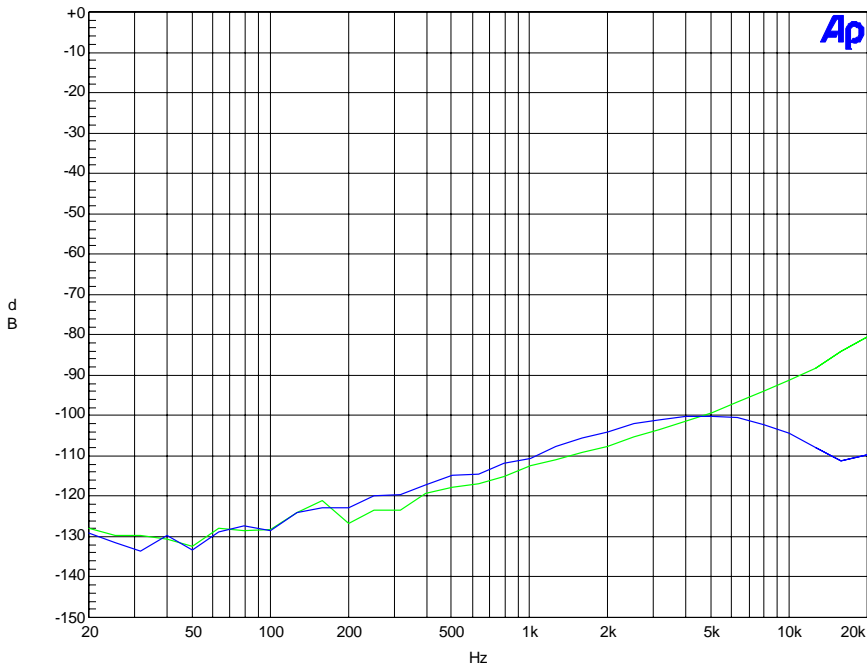

Figure 52, Setup 6 Cross talk: Ch1 1000ASP to Ch2 1000A and Ch2 1000A to Ch1 1000ASP.

*Power duration measurements*

Power duration measurements record the elapsed time after the introduction of a power step until the output is attenuated to a safe power level by the onboard protection system (Please refer to page 12 for a full description). Measurements marked with \* indicate loss of output power.

- Stepping the power load on the ASP-module

Module	Input Frequency	Preload power	Stepped power
1000ASP	880 Hz	500 W @ 4 Ω	1000 W @ 4 Ω
1000A	1 kHz	500 W @ 4 Ω	500 W @ 4 Ω

	Power duration [ms] (t <sub>150</sub> )	
	1000ASP	1000A
120 Volt bus without extra capacitor	33	> 2000
120 Volt bus with extra capacitor 8800 uF	70	> 2000

- Stepping the power load on the hanger module

Module	Input Frequency	Preload power	Stepped power
1000ASP	880 Hz	500 W @ 4 Ω	500 W @ 4 Ω
1000A	1 kHz	500 W @ 4 Ω	1000 W @ 4 Ω

	Power duration [ms] (t <sub>150</sub> )	
	1000ASP	1000A
120 Volt bus without extra capacitor	33	50
120 Volt bus with extra capacitor 9400 uF	70	> 2000

## Notice

The data sheet contains specifications that may be subject to change without prior notice. ICEpower® is a trademark of Bang & Olufsen ICEpower a/s.

Bang & Olufsen ICEpower a/s products are not authorized for use as critical components in life support devices or systems without the express written approval of the president and general counsel of Bang & Olufsen ICEpower a/s. As used herein:

1. Life support devices or systems are devices or systems which, (a) are intended for surgical implant into the body, or (b) support or sustain life, and whose failure to perform when properly used in accordance with instructions for use provided in the labeling, can be reasonably expected to result in a significant injury to the user.
2. A critical component is any component of a life support device or system whose failure to perform can be reasonably expected to cause the failure of the life support device or system, or to affect its safety or effectiveness.

## Appendix 1 - Recommended wiring diagram

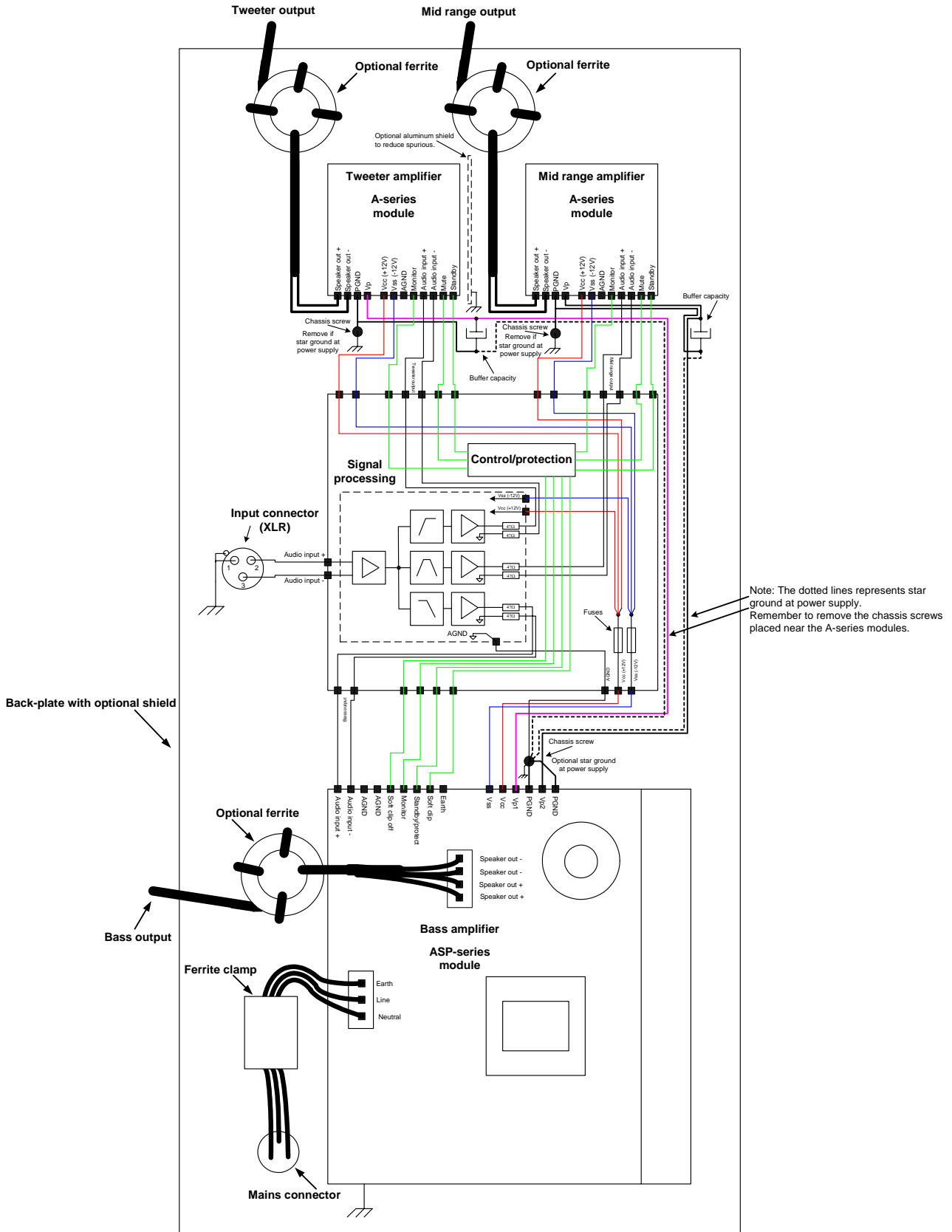

## Appendix 2 - Recommended shielding box design for parallel mounting

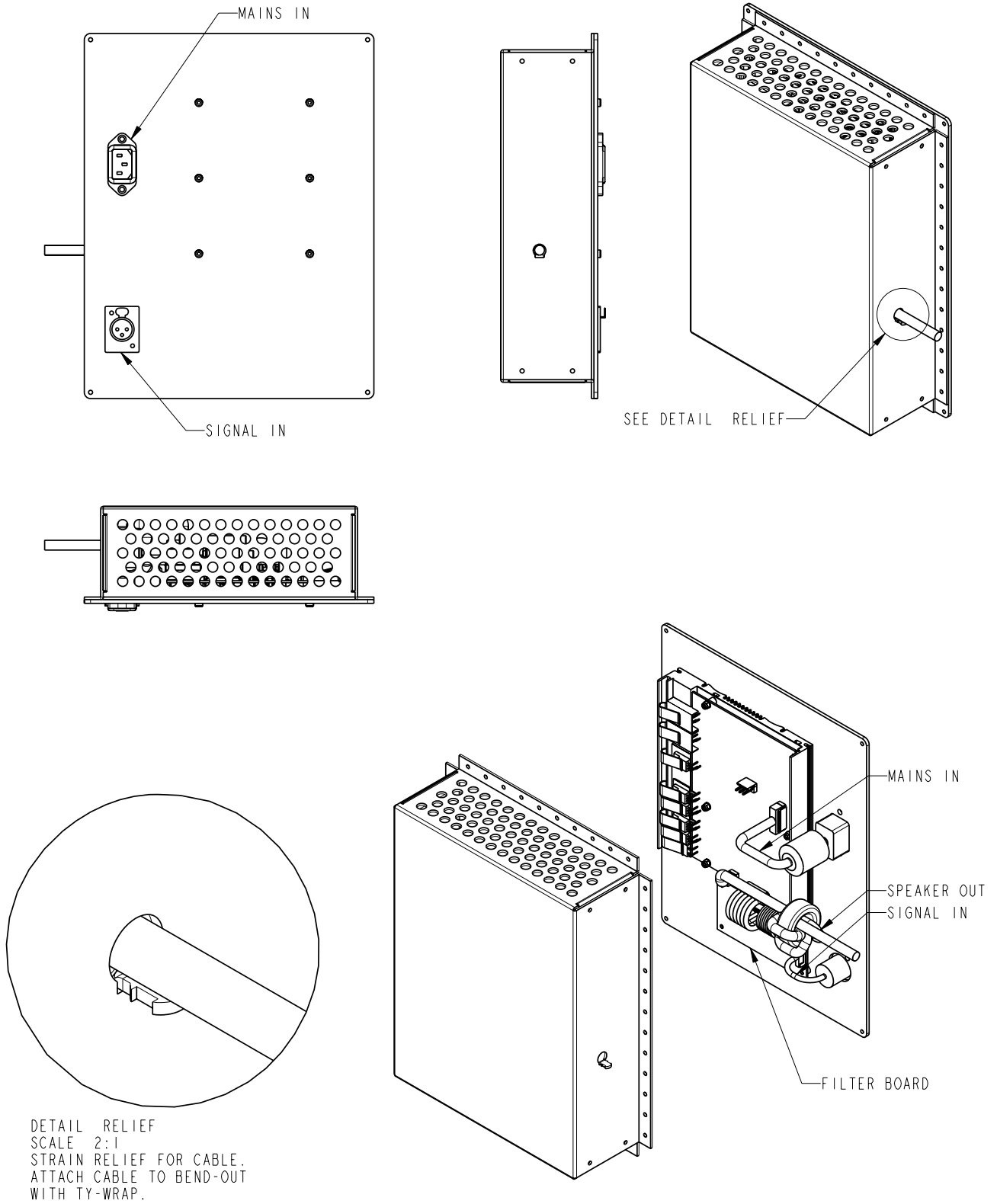

### Appendix 3 - Recommended shielding box design for perpendicular mounting

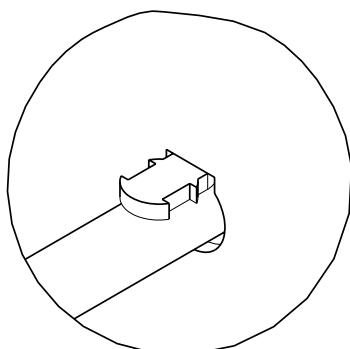
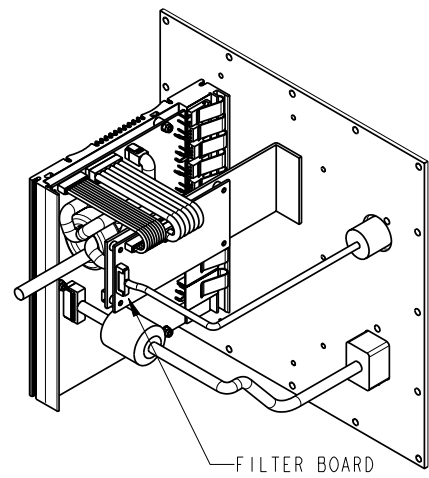
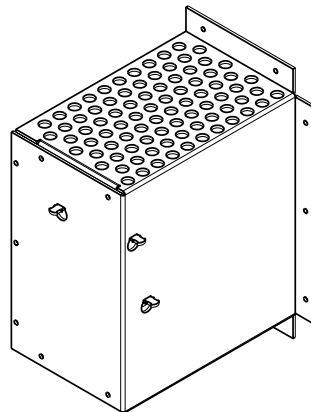
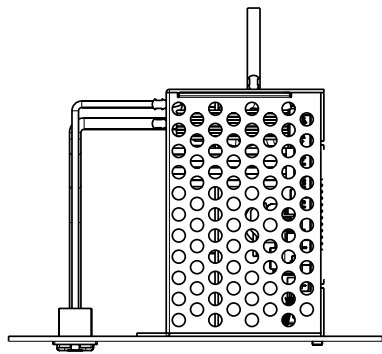
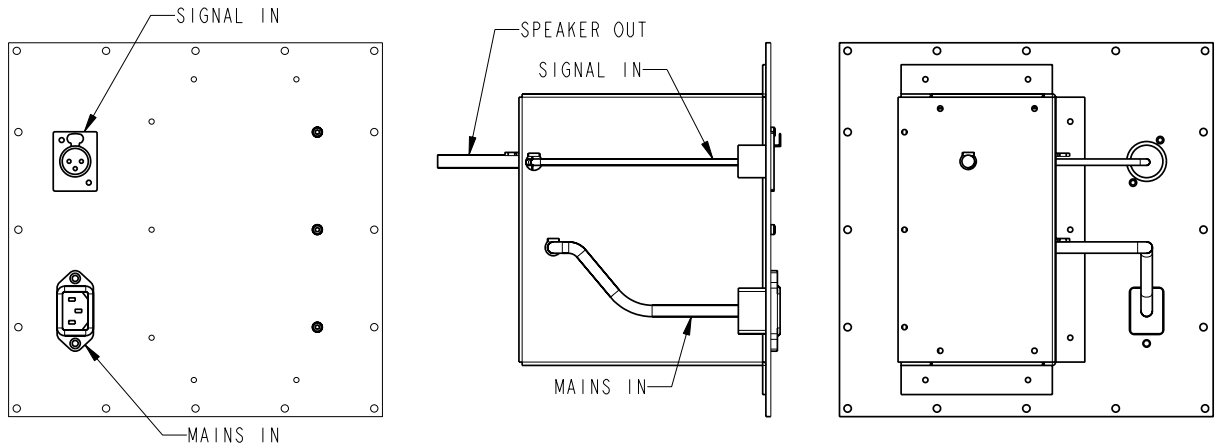

DETAIL RELIEF  
SCALE 2:1  
STRAIN RELIEFS FOR CABLES.  
ATTACH CABLE TO BEND-OUT  
WITH TY-WRAP

